



**VHF/UHF DUAL BAND FM TRANSCEIVER**

# **FTM-10R**

## **OPERATING MANUAL**



**VERTEX STANDARD CO., LTD.**

4-8-8 Nakameguro, Meguro-Ku, Tokyo 153-8644, Japan

**VERTEX STANDARD**

**US Headquarters**

10900 Walker Street, Cypress, CA 90630, U.S.A.

**YAESU EUROPE B.V.**

P.O. Box 75525, 1118 ZN Schiphol, The Netherlands

**YAESU UK LTD.**

Unit 12, Sun Valley Business Park, Winnall Close  
Winchester, Hampshire, SO23 0LB, U.K.

**VERTEX STANDARD HK LTD.**

Unit 5, 20/F., Seaview Centre, 139-141 Hoi Bun Road,  
Kwun Tong, Kowloon, Hong Kong

**VERTEX STANDARD (AUSTRALIA) PTY., LTD.**

Normanby Business Park, Unit 14/45 Normanby Road  
Notting Hill 3168, Victoria, Australia

---

---

# Contents

---

---

<b>Features</b> .....	1	Using the Stop Watch Timer .....	55
<b>Front Panel &amp; Top Panel</b> .....	4	Using the Interval Timer .....	55
<b>Rear Panel &amp; LCD</b> .....	6	<b>Convenience Features</b> .....	56
<b>Accessories &amp; Options</b> .....	8	MUTE feature .....	56
Supplied Accessories .....	8	LOCK .....	56
Optional Accessories .....	9	Automatic Audio Volume Controller .....	56
<b>Installation</b> .....	10	AF-VFO feature .....	57
Preliminary Inspection .....	10	VOX Operation .....	57
Installation Tips .....	10	VOX Sensitivity .....	58
Safety Information .....	11	Listening to AM/FM Broadcast Station .....	58
Mobile Installation .....	12	Time-Out Timer (TOT) .....	58
Base Station Installation .....	14	<b>Listening to external audio input</b> .....	59
Antenna Considerations .....	15	<b>Bluetooth® Operation</b> .....	60
Separate Installation .....	16	<b>AF Dual Function</b> .....	62
Non-Separate Installation .....	21	<b>CTCSS Operation</b> .....	64
<b>Basic Operation</b> .....	22	<b>DCS Operation</b> .....	65
Receive .....	22	<b>EPCS (Enhanced Paging &amp;</b>	
Transmission .....	23	<b>Code Squelch) Operation</b> .....	66
<b>Smart Menu Features</b> .....	24	<b>Internet Connection Feature (WiRES™)</b> .....	68
AF Dual Function .....	25	<b>DTMF Autodialer</b> .....	71
ARTS™ .....	26	<b>Repeater Operation</b> .....	73
Dimmer function .....	27	<b>Band Expansion</b> .....	74
Horn Alert feature .....	27	<b>Weather Broadcast Channel Operation</b> .....	75
Intercom Function .....	28	<b>Miscellaneous Setting</b> .....	76
Monitor feature .....	28	Channel Step Selection .....	76
Public Address feature .....	29	Changing the Operating Mode .....	76
Reverse feature .....	29	PTT key function .....	77
Scan feature .....	30	Key Beeper .....	77
Smart Search™ Operation .....	30	Smart Key Select .....	77
Squelch Level Adjust .....	31	Repeater Shift Direction .....	78
TCALL .....	32	Repeater Shift Offset .....	78
TX Power Select .....	32	Automatic Repeater Shift .....	78
Intercom Volume Control .....	32	Programming the Key Assignments .....	79
<b>Memory Operation</b> .....	33	Scanning Band .....	80
Memory Storage .....	33	Scan-Resume Mode .....	80
Memory Recall .....	34	Scan Direction .....	81
Memory Channel Customization .....	35	Scan Start Direction .....	81
Memory Group Bank .....	36	Split Tone Operation .....	82
Memory Channel Number Change .....	37	CTCSS/DCS/EPCS Bell Operation .....	82
Memory Channel Sort .....	37	Battery Voltage Display .....	83
Labeling Memory .....	38	Temperature Display .....	83
Scan Type .....	39	Clock Format .....	83
Skip/Preferential Scan Setting .....	39	Time System .....	84
Squelch Level .....	40	Alarm Set .....	84
CTCSS frequency .....	40	Interval Beep .....	84
DCS code .....	41	Automatic Power-Off (APO) .....	85
CTCSS/DCS Operation .....	41	Audio Pitch Control .....	85
Storing Independent Transmit		Volume Setting Alert feature .....	86
Frequency (Odd Split) .....	42	Speaker Selection .....	86
Transmitter Power Level .....	43	Stereo/Monaural Selection .....	87
Deleting Memory .....	43	MIC Gain Setting .....	87
<b>Club Channel Operation</b> .....	44	PTT Lock .....	87
Recalling the Club Channel .....	44	<b>Menu (“Set”) Mode</b> .....	88
Activating the Club Channel Monitor .....	44	<b>Appendix</b> .....	101
<b>Message Feature</b> .....	46	MH-68B6J Microphone .....	101
Programming a Message .....	46	MH-68A6J Microphone .....	101
Programming a Member List .....	47	<b>Installation of Optional Accessories</b> .....	102
Cloning the Message .....	48	Microphone Jack “MEK-M10” .....	102
Set your Personal ID .....	49	BU-1 <b>Bluetooth®</b> Adapter Unit .....	104
Sending Messages .....	49	CAB-1 <b>Bluetooth®</b> Head Set	
Cloning .....	50	Charger Sleeve .....	106
Changing the Club Channel frequency .....	52	<b>Reset Procedure</b> .....	107
<b>Clock/Timer Operation</b> .....	53	<b>Troubleshooting</b> .....	108
Set up the Clock .....	53	<b>Specifications</b> .....	109
Displays the Current Time .....	54		



### ***New Concept in Ultra compact Mobile transceivers***

The ultra small size and design of this radio gives you many choices for mounting and using this radio in your vehicle. The front panel may be separated from the main unit providing many placement and mounting options even for motor cycles or off road vehicles. The microphone and the PTT switch are installed on the front panel so you can transmit without connecting any microphone. You will not need an additional microphone or cable to interfere with your driving on the road.

### ***Simple set-up and no microphone or curl cord needed***

The one touch, quick release front panel holder (new type) and the mounting bracket allow you to place the front panel anywhere you want. The newly designed mobile mounting bracket allows you to install or release the radio very easily.

The front panel has a magnet and it is possible to install it without using screws.

An angled panel adapter is included. The front panel may be adjusted up to 30 degrees inclination to allow an improved, comfortable operating position.

### ***Convenient Operation***

The large function dial and key buttons afford simple operation, even while wearing driving gloves. The shape, size and position of the keys have been studied carefully. The design will help avoid miss-operation of the keys while operating the vehicle.

### ***Water proof front panel***

The front panel is engineered to IP57 waterproof standards. You can mount the panel on the handle bar of a motorcycle.

### ***Superb visibility with new LCD panel***

The bright LED and the Ocean Blue color LCD assure comfortable viewing night or day.

# FEATURES

---

## **Great new options to optimize your Motor Sports activities**

-- Hands free operation with optional **Bluetooth®** headset--

When the optional **Bluetooth®** stereo headset is used with the optional **Bluetooth®** unit and charger sleeve, you can enjoy comfortable hands free operation while you are driving. Using the high audio output external speaker, the magnetic mounting brackets and the **Bluetooth®** unit can provide hands-free operation and unlimited possibilities when using this radio in any Motor Sports activity.

## **Reliable and advanced performance**

The final transmitter amplifier produces up to 50 watts VHF and 40 watts UHF of reliable and stable high power RF output.

The radio has wide receiving frequency capability, and an independent AM/FM broadcast receiver. The Amateur radio receiver is specially designed for optimal Amateur band operation, with improved adjacent channel selectivity and IMD performance. You will appreciate the superior performance of the receiver when operating in strong electro magnetic signal environments. The rugged chassis construction provides great reliability in any environment you may encounter on the car or the bike.

## **Loud Audio operation**

A 2 inch speaker is mounted inside of the radio to provide powerful, low distortion AF output. The high volume will give excellent audio recognition, even in very noisy environments.

Also available is a **MLS-200-M10** optional external speaker. You can have loud audio output with the 8 Watt AF amplifier built into the radio.

## **Sturdy rear chassis**

A large aluminum die cast chassis forms a very sturdy rear case, and effectively radiates the heat from the RF amplifier without the need of a cooling fan. The sandwich construction of the chassis shields the electrical circuits from alternator and ignition noise. You have worry free operation during long hours of rough handling in harsh environments.

## **Advanced features to support many Motor Sport activities.**

- 500 memory channels with alpha-numeric labels.
- High output audio amplifier and optional external loudspeaker.
- The PA (Public Address) function permits communicating with a loud voice.
- The Intercom function provides communication through headphones between passengers in the vehicle. Also the **Bluetooth®** unit can be used for the intercom.
- An AM /FM broadcast receiver is included. Audio line input is provided for connection to your iPod® (FM broadcast and external input have stereo audio available)
- AF preset function alerts you when the AF audio level is changed by accident. You enjoy the appropriate and optimized setting of volume level.

# *FEATURES*

---

- The message send/receive function permits sending a programmable 16 character message with the transmitter's ID. You can send your words by "Message" function even when the noise level at the opposite station is too high for audio communication.
- The wireless clone feature permits the settings and data of the radio to be duplicated in other radios without connecting any wires. All the radios in your group traveling together can have the same settings with the easy cloning operation.
- A convenient stopwatch function and display includes a Lap counter, Interval Timer/Alert and Time.
- VOX is installed for hands free operation.
- Many new features include: Tone Control, One-touch band selection, Automatic audio level control, Dimmer, TOT, WiRES, DC supply voltage indication, and APO.

# FRONT PANEL & TOP PANEL

## / keys

These keys select the following operations.

- AF Dual Feature (See page 25)
- ARTS Feature (See page 26)
- Display Dimmer (See page 27)
- Horn Alert Feature (See page 27)
- Intercom Operation (See page 28)
- Monitor Feature (See page 28)
- Public Address (See page 29)
- Volume Level Control while Intercom Operation (See page 32)
- Reverse (See page 29)
- Scan Operation (See page 30)
- Smart Search Operation (See page 30)
- Squelch Threshold Level (See page 31)
- TCALL (See page 32)
- TX Power Level (See page 32)

## PTT keys

Press this key to transmit.

Speak into the microphone while pressing this key.

- Release this key to return to receive.
- You may change this key function to “toggle” mode (toggle the “transmit” and “receive” mode each time the key is pressed). (See page 77)

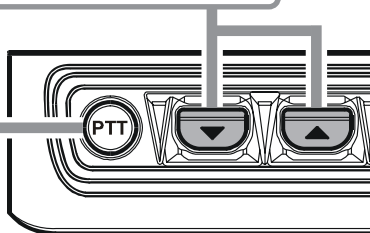

## MIC

The internal microphone is located here. Speak into the grill in a normal voice level while pressing the PTT key.

## TX/BUSY Indicator

This indicator glows **green** when a signal is received.

This indicator glows **red** during transmission.

This indicator blinks **blue** when a message is received.

This indicator glows **white** when transmitting a message.

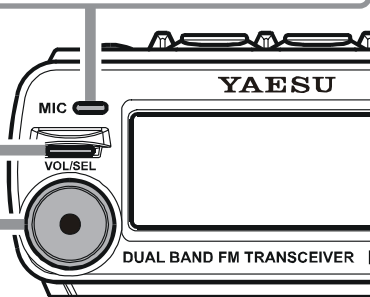

## VOL/SEL key

You may adjust the receiver audio level with the DIAL knob after pressing this key.

- The LED to the left of the DIAL knob will glow red when the DIAL knob is set to control the receiver audio level.
- Press this key again or wait for three seconds, to cancel control of the audio level by the Dial knob.



Mute Function:

Press and hold this key for one second to temporarily mute the receiver audio.

Press this key again to restore the receiver audio.

# FRONT PANEL & TOP PANEL

## key

Press this key to activate the function that is selected by the /  keys.

## POWER key

Press and hold this key for two seconds to toggle the transceiver's power on or off.

Lock Function:

Press this key momentarily while the transceiver is turned on to toggle the key lockout feature on or off.

○ You may also lock out the PTT key when the LOCK mode is activated, by changing Menu Item "F22 PTT LOCK". See page 87.

## key

○ This key switches frequency control between the VFO and Memory System.

○ In the VFO mode, press and hold this key for one second to enter the Memory Write mode and then press this key again to store the frequency into the memory.

○ In the Memory mode, press and hold this key for one second to enter the Memory Channel Customization mode.

## DIAL knob

○ Selects the operating frequency and also selects the memory channel.

○ Adjusts the receiver audio level when the LED to the left of the DIAL knob glows red.

○ Select the Smart Menu Item and parameter when the Smart Menu is activated.

## LED

○ This LED glows red when adjusting the receiver audio level with the DIAL knob.

○ This LED blinks orange when the Volume Setting Alert feature is active.

○ This LED blinks yellow when the Timer feature is active.

## / keys

○ Press these keys to switch the operating band as follows:

↔ 2 m Amateur Band ↔ 430 MHz Amateur Band ↔ FM BC Band ↔ AM BC Band ↔

↔ WX Band ↔ Audio Line ↔ Group Channel ↔ 2 m Amateur Band ↔

○ Press and hold this key for one second (MHz digits will blink), then rotate the DIAL knob to change the frequency in 1 MHz steps.

# REAR PANEL & LCD

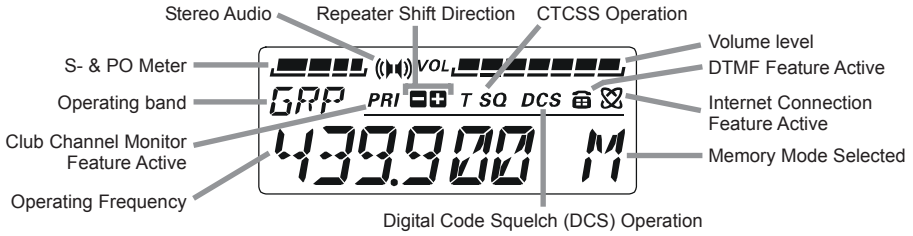

## DC 13.8 V Cable Pigtail w/Fuse

Connect this pigtail to the car battery directly with the supplied DC cable.

- Connect the red lead to the positive side (+) of the battery and connect the black lead to the negative side (-) of the battery. The DC cable is as short as possible, because transmitting requires a high DC electrical current flow.
- Performance may be significantly reduced when connecting the DC cable to the cigarette lighter plug or fuse box.
- Install a line filter if your vehicle has objectionable alternator noises.

## ANT jack

Connect an efficient 144/430 MHz antenna, which is adjusted to 50-Ohm impedance. Use low-loss 50-Ohm coaxial cable with type-M (PL259) connector.

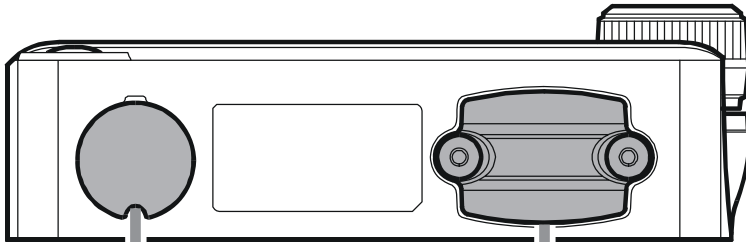
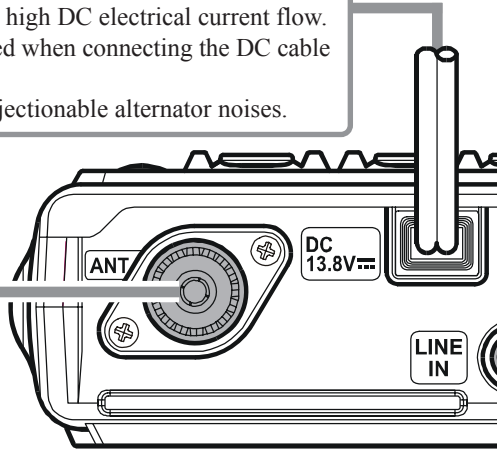

You may connect an optional CAB-1 Bluetooth® Head Set Charger Sleeve here.

You may connect an optional MEK-M10 Microphone Jack here.



## MIC jack

You may connect an optional MH-68A6J or MH-68B6J Hand Microphone to this jack if you use.

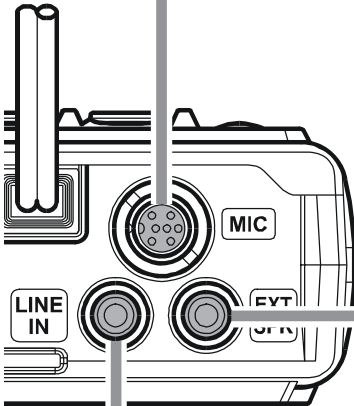

## EXT SPK jack

This 3-contact 3.5-mm mini stereo-phone jack provides receiver audio output for an optional external speaker. The audio impedance is 4 Ohms, and the level varies according to the setting of the front panel VOL control.

- Inserting a plug into this jack disables audio from the transceiver's internal speaker.
- When stereo speakers are connected to this jack, and the Menu item "F42 STEREO" is set to "STEREO", you may enjoy FM Broadcast audio, or the external audio from the LINE IN jack in stereo.
- If there is no audio output from the external speakers when connected to this jack, confirm that the Menu item "F34 SPEAKER" is set to "REAR" (See page 86).
- Use of a sound isolating headset while driving on public roads is not lawful. An open type headset must be used for safety.

Hint: Menu Mode

The **FTM-10R** Menu enables the configuration of 49 transceiver parameters to your favorite settings.

## LINE IN jack

Connect an external audio source (such as the iPod®) to this jack using the after-market audio cable.

When using the audio line input to this jack, you may enable the receiving of amateur signals while listening to your favorite music.

Adjust the input level with the volume control of the external audio equipment connected.

The connection cable depends on the external audio equipment you connect. Please ask your dealer.

# ACCESSORIES & OPTIONS

---

## SUPPLIED ACCESSORIES

---

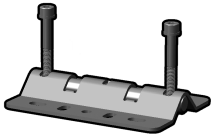

Mobile Mounting Bracket



DC Power Cord W/Fuse



Spare Fuse (15 A)



Angle Adapter



Separation Cable (3 m)

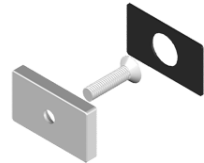

Magnet



Front Panel Bracket



Front Panel Hanger



Speaker Cable

Hex Wrench (4 mm)

Hex Wrench (3 mm)

Operating Manual

Warranty Card

# ACCESSORIES & OPTIONS

## OPTIONAL ACCESSORIES



**MH-68A6J**

DTMF Microphone



**MH-68B6J**

Normal Microphone



**MEK-M10**

Microphone Jack



**MLS-200-M10**

High-Power External  
Speaker



**MMB-M10**

Multi-Angle Bracket

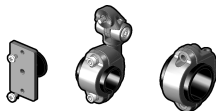

**MMB-M11**

Handle Bar Bracket



**CT-M10**

Separation Cable (6 m)



**BH-1**

**Bluetooth**<sup>®</sup> Headset



**BU-1**

**Bluetooth**<sup>®</sup> Adapter Unit



**CAB-1**

**Bluetooth**<sup>®</sup> Headset  
Charger Sleeve

**FEP-4**

Ear Phone for BH-1

**CT-M11**

Connection Cable

*Availability of accessories may vary in some regions. This product is designed to perform optimally when used with genuine Vertex Standard accessories. Vertex Standard shall not be liable for any damage or accidents such as fire, leakage or explosion of batteries, etc., caused by the malfunction of non-Vertex Standard accessories. Consult your Vertex Standard dealer for details on these and any future available options. Connection of any non-Vertex Standard-approved accessory, should it cause damage, may void the Limited Warranty on this apparatus.*

# *INSTALLATION*

---

This chapter describes the installation procedure for integrating the **FTM-10R** into a typical amateur radio station. It is presumed that you possess technical knowledge and conceptual understanding consistent with your status as a licensed radio amateur. Please take some extra time to make certain that the important safety and technical requirements detailed in this chapter are followed closely.

---

## **PRELIMINARY INSPECTION**

---

Inspect the transceiver visually immediately upon opening the packing carton. Confirm that all controls and switches work freely, and inspect the cabinet for any damage. Gently shake the transceiver to verify that no internal components have been shaken loose due to rough handling during shipping.

If any evidence of damage is discovered, document it thoroughly and contact the shipping company (or your local dealer, if the unit was purchased over-the-counter) so as to get instructions regarding the prompt resolution of the damage situation. Be certain to save the shipping carton, especially if there are any punctures or other evidence of damage incurred during shipping. If it is necessary to return the unit for service or replacement, use the original packing materials. Then put the entire package inside another packing carton to preserve the evidence of shipping damage for insurance purposes.

---

## **INSTALLATION TIPS**

---

To ensure long life of the components, be certain to provide adequate ventilation around the cabinet of the **FTM-10R**.

Do not install the transceiver on top of another heat-generating device (such as a power supply or amplifier). Avoid heating vents and window locations that could expose the transceiver to excessive direct sunlight, especially in hot climates. The **FTM-10R** should not be used in an environment where the ambient temperature exceeds +140 °F (+60 °C).

---

## SAFETY INFORMATION

---

The **FTM-10R** is an electrical apparatus, as well as a generator of High RF (Radio Frequency) energy. You should exercise all safety precautions that are appropriate for this type of device. These safety tips apply to any device installed in a well-designed amateur radio station.



Never allow unsupervised children to play in the vicinity of your transceiver or antenna installation.



Be certain to wrap any wire or cable splices thoroughly with insulating electrical tape, to prevent short circuits.



Do not route cables or wires through doorjambes or other locations where they may become frayed and shorted to ground or to each other.



Do not stand in front of a directional antenna while you are transmitting into that antenna. Do not install a directional antenna in any location where humans or pets may walk in the main directional lobe of the antenna's radiation pattern.



In mobile installations, it is preferable to mount the antenna on top of the vehicle, if feasible, this will utilize the car body as a counterpoise and raise the radiation pattern as far away from passengers as possible.



During mobile operation when stopped (in a parking lot, for example), make it a practice to switch to Low power if there are people walking nearby.



Never wear dual-earmuff headphones while driving a vehicle.



Do not attempt to drive your vehicle while making a telephone or auto patch call while using the optional DTMF microphone. Pull over to the side of the road, whether dialing manually or using the auto-dial feature.

**Warning!:** High RF voltage is present in the TX RF section of the transceiver while transmitting. Do not touch the TX RF section while transmitting.

# INSTALLATION

---

---

## MOBILE INSTALLATION

---

---

The **FTM-10R** must only be installed in vehicles having a 13.8 Volt negative ground electrical system. Mount the transceiver where the display, controls, and microphone are easily accessible, using the supplied Mobile Mounting Bracket.

The transceiver may be installed in almost any location, but should not be positioned near a heating vent or anywhere where it might interfere with driving (either visually or mechanically). Make sure to provide plenty of space on all sides of the transceiver so that air can flow freely around the radio's case.

An antenna and an antenna cable are not included in the box. Purchase them separately to accommodate your transceiver installation.

- The DC power cable draws a large current when transmitting. The power cable should be wired as short as possible, and connected directly to the battery. (Do not use the cigarette lighter socket for power connections).
- Never remove the fuse holders from the DC cables
- Never connect the transceiver directly to a 24 V battery.
- Select a low-loss coaxial cable to connect the transceiver with the antenna. Use the shortest length possible.
- Select a quality, high efficiency VHF/UHF antenna, and mount it in a good location on the car to obtain the maximum performance from the transceiver. (NOTE: An antenna designed with a matching device that forms a low DC resistance to ground may have poor reception on the AM broadcast band.)
- The antenna depends on good grounding to realize maximum performance. Contact your dealer for information on transceiver and antenna installation.
- If alternator noise exists, use a line filter in the DC power cable connection.

**IMPORTANT:** Select a location which can support the weight of the **FTM-10R** transceiver and does not interfere with your driving.

## Mobile Power Connections

To minimize voltage drop and avoid blowing the vehicle's fuses, connect the supplied DC power cable directly to the battery terminals. **Do not attempt to defeat or bypass the DC cable fuse - it is there to protect you, your transceiver, and your vehicle's electrical system.**

### Warning!

**Never apply AC power to the power cable of the FTM-10R, nor DC voltage greater than 15.8 Volts. When replacing the fuse, use only a 15-A fuse. Failure to observe these safety precautions will void the Limited Warranty on this product.**

- Before connecting the transceiver, check the voltage at the battery terminals while revving the engine. If the voltage exceeds 15 Volts, repair the vehicle's voltage regulator before proceeding with installation.
- Connect the **RED** power cable lead to the **POSITIVE (+)** battery terminal, and the **BLACK** power cable lead to the **NEGATIVE (-)** terminal. If you need to extend the power cable, use #12 AWG or larger insulated, stranded copper wire. Solder the splice connections carefully, and wrap the connections thoroughly with insulating electrical tape.
- Before connecting the cable to the transceiver, verify the voltage and polarity of the voltage at the transceiver end of the DC cable using a DC voltmeter. Now connect the transceiver to the DC cable.

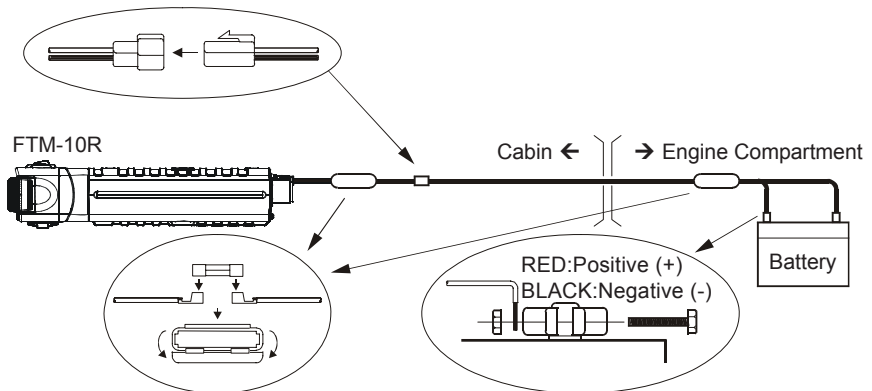

## Mobile Speakers

The optional **MLS-200-M10** High-Power External Speaker includes its own swivel-type mounting bracket, and is available from your Yaesu dealer.

Other external speakers may be used with the **FTM-10R**, if they present the specified 8-Ohm impedance and are capable of handling the 8 Watts of audio output supplied by the **FTM-10R**.

# *INSTALLATION*

---

---

## **BASE STATION INSTALLATION**

---

The **FTM-10R** is ideal for base station use as well as in mobile installations. The **FTM-10R** is specifically designed to integrate into your station easily, using the following information as a reference.

### **AC Power Supplies**

Operation of the **FTM-10R** from an AC line requires a power supply capable of providing at least 9 Amps continuously at 13.8 Volts DC. The **FP-1025A** and **FP-1030A** DC Power Supplies are available from your Yaesu dealer to satisfy these requirements. Other well-regulated power supplies may be used if they meet the above voltage and current specifications.

Use the DC power cable supplied with your transceiver to make power connections to the power supply. Connect the **RED** power cable lead to the **POSITIVE (+)** power supply terminal, and connect the **BLACK** power cable lead to the **NEGATIVE (-)** power supply terminal.



---

---

## ANTENNA CONSIDERATIONS

---

---

The **FTM-10R** is designed for use with antennas presenting an impedance of near 50 Ohms at all operating frequencies. To avoid damage that could result if transmission occurs accidentally without an antenna, the antenna (or a 50 Ohm dummy load) should be connected whenever the transceiver is turned on.

Ensure that your antenna is designed to handle 50 Watts of transmitter power. Some magnetic-mount mobile antennas, designed for use with hand-held transceivers, may not be capable of withstanding this power level. Consult the antenna manufacturer's specification sheet for details.

Use high-quality 50-Ohm coaxial cable for the lead-in to your **FTM-10R** transceiver. All efforts at providing an efficient antenna system will be wasted if poor quality, "lossy" coaxial cable is used. Losses in coaxial lines increase as the frequency increases, so an 8-meter-long (25') coaxial line with under 1 dB of loss at 144 MHz may have a loss of 3 dB or more at 446 MHz. Choose your coaxial cable carefully based on the installation location (mobile vs. base) and the overall length of the cable required. (For very short runs of cable in a mobile installation, the smaller, more flexible cable types may be acceptable.)

For reference, the chart below shows approximate loss figures for typically available coaxial cables frequently used in VHF/UHF installations.

### Loss in dB per 30 m (100 feet) for Selected 50-Ohm Coaxial Cables

(Assumes 50-Ohm Input/Output Terminations)

CABLE TYPE	Loss: 144 MHz	Loss: 430 MHz
RG-58A	6.5	> 10
RG-58 Foam	4.7	8
RG-213	3.0	5.9
RG-8 Foam	2.0	3.7
Belden 9913	1.5	2.9
Times Microwave LMR-400	1.5	2.6
7/8" "Hardline"	0.7	1.3

*Loss figures are approximate; consult cable manufacturers' catalogs for complete specifications.*

In outdoor installations, be certain to weatherproof all connectors thoroughly, as water entering a coaxial cable will cause losses to escalate rapidly, thus diminishing your communications effectiveness. The use of the shortest possible length of the highest quality coaxial cable that fits within your budget will ensure the best performance from your **FTM-10R**.

Your dealer should be able to assist you with all aspects of your antenna installation requirements.

## SEPARATE INSTALLATION

1. Remove the four screws securing the Front Panel and then remove the Front Panel from the Transceiver Body (Figure 1).
2. Disconnect the 8-pin modular plug from the Transceiver (Figure 2).
3. Remove the screw affixing the Straight Sub Panel, and then remove the Straight Sub Panel from the Front Panel (Figure 3).
4. Remove the four screws securing the Rear Case of the Front Panel and remove the Rear Case from the Front Panel (Figure 4). Disconnect the Connector of the Connection Cable from the Printed Circuit Board in the Front Panel when you remove the Rear Case (Figure 5).
5. Remove the Binding Plate from the Rear Case (Figure 6-①), and then pull out the Connection Cable from the Rear Case (Figure 6-②).

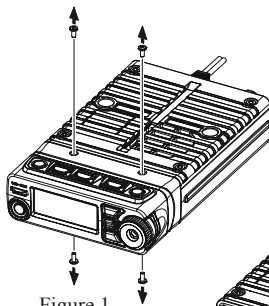

Figure 1

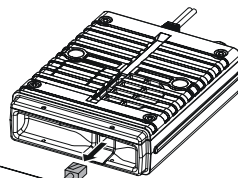

Figure 2

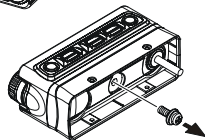

Figure 3

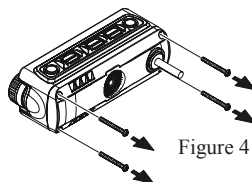

Figure 4

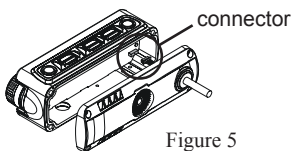

Figure 5

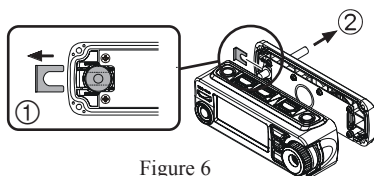

Figure 6

## SEPARATE INSTALLATION

6. Insert the supplied 3-m Connection Cable from the rear side of Rear Case (Figure 7-①), and then attach the Connection Cable to the Rear Case using the previously removed Binding Plate (Figure 7-②).
7. Attach the Connection Cable to the Printed Circuit Board (Figure 8), and then replace the Rear Case to the Front Panel using the previously removed four screws (Figure 9).
8. Connect the 8-pin modular plug of the Connection Cable to the Transceiver (Figure 10).
9. Mount the supplied Mobile Mounting Bracket to the any position using the supplied screws (Figure 11).

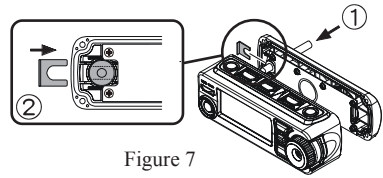

Figure 7

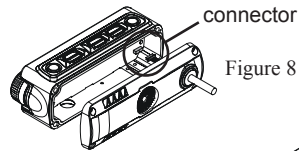

Figure 8

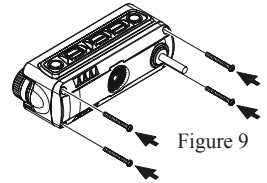

Figure 9

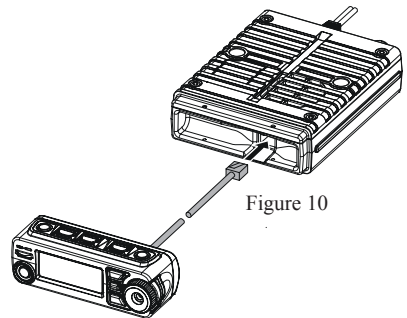

Figure 10

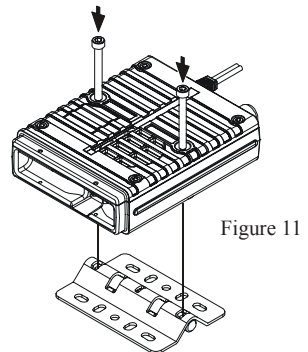

Figure 11

# INSTALLATION

## SEPARATE INSTALLATION

### Front Panel Installation

Use the supplied Front Panel Bracket

1. Mount the supplied Front Panel Bracket to any suitable position using the supplied screws.
2. Connect the supplied Front Panel Hanger using the supplied screw.
3. Install the Front Panel into the Front Panel Bracket.

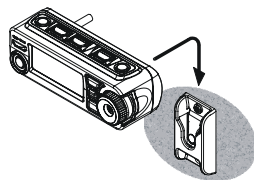
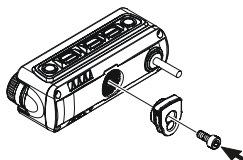
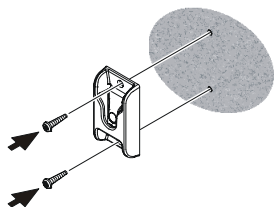

Use the supplied Magnet

1. Connect the supplied Magnet and Front Panel Hanger using the supplied screw.
2. Affix the supplied Protection Seal to the Magnet.

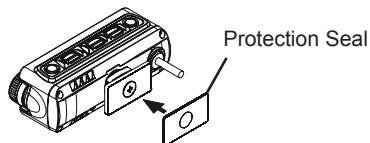
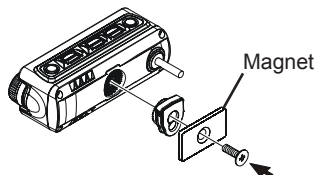

### CAUTION!

- If the protective film is not affixed to the magnet, it may damage the mounting surface.
- Damage is possible even if the protection film is attached.
- Be careful handling the hanger. The strong magnet could pinch your fingers.
- Even with the strong magnet, it is possible to displace the bracket.
- The magnet may destroy data on banking & identification cards.

## SEPARATE INSTALLATION

Use the Optional Multi-Angle Bracket “**MMB-M10**”

1. If you use the Front Panel as a Microphone, connect the supplied Front Panel Hanger using the supplied screw.
2. Mount the supplied Front Panel Bracket to the “**MMB-M10**” using the supplied two screws.

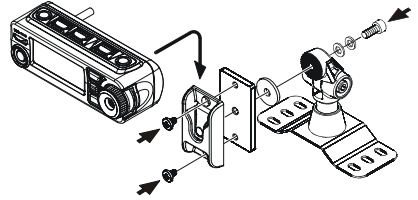
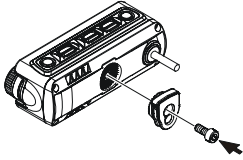

3. If you do not use the Front Panel as a Microphone, install the Front Panel directly to the “**MMB-M10**”.

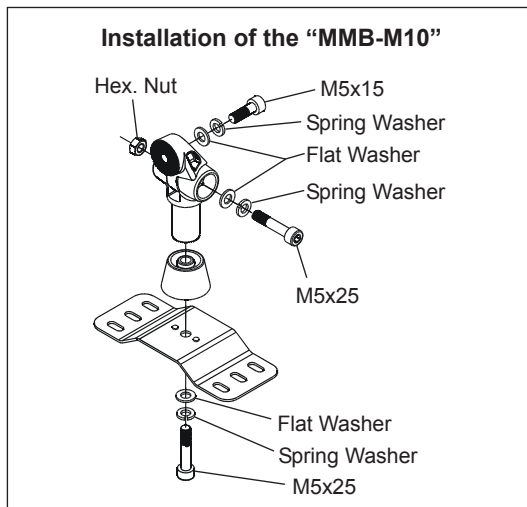
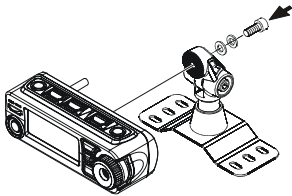

# INSTALLATION

## SEPARATE INSTALLATION

Use the Optional Handle Bar Bracket “**MMB-M11**”

1. If you use the Front Panel as a Microphone, connect the supplied Front Panel Hanger using the supplied screw.
2. If you do not use the Front Panel as a Microphone, install the Front Panel directly to the “**MMB-M11**”.

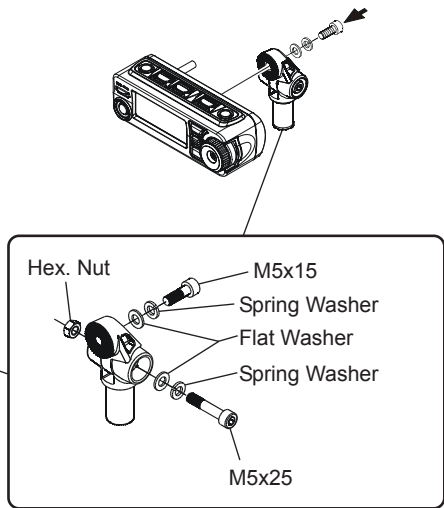
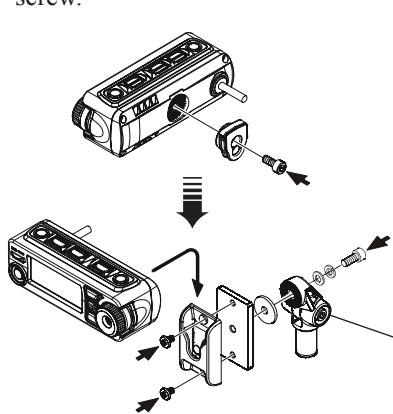

3. Select the Bracket and Rubber to fit the size of the Handle Bar (Refer to the table below).

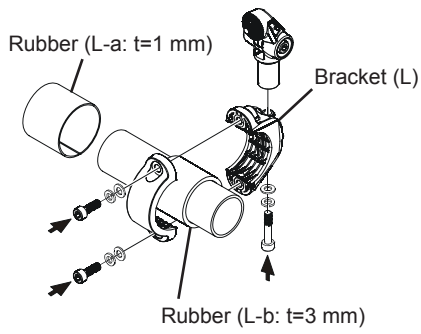
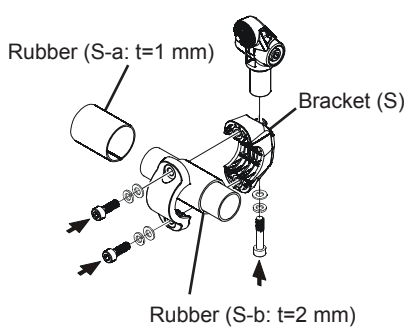

Bar	Bracket	Rubber
7/8"	S	S-a & S-b
1"		S-a
1-1/4"	L	L-a & L-b
1-1/2"		L-a

## NON-SEPARATE INSTALLATION

The **FTM-10R** front panel may be tilted using the supplied Angle Sub Panel.

1. Remove the four screws securing the Front Panel and then remove the panel from the transceiver body (Figure 1).
2. Disconnect the 8-pin modular plug from the transceiver (Figure 2).
3. Remove the screw affixing the Straight Sub Panel, and then remove the Straight Sub Panel from the Front Panel (Figure 3).
4. Attach the supplied Angle Sub Panel to the Front Panel, using the previously removed screw (Figure 4).  
You may set this up in a “look-up” or “look-down” configuration depending on the mounting position of the Sub Panel.
5. Connect the 8-pin modular plug to the transceiver’s body.
6. Attach the Front Panel (with Angle Sub Panel) to the transceiver’s body, using the previously removed four screws (Figure 5).

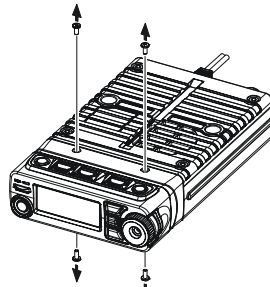

Figure 1

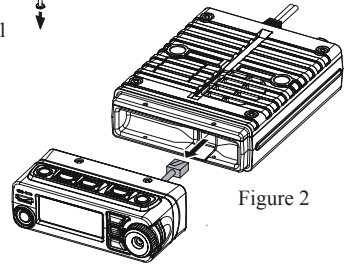

Figure 2

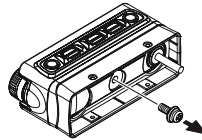

Figure 3

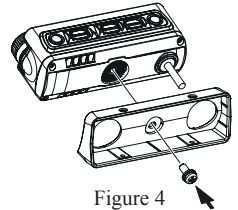

Figure 4

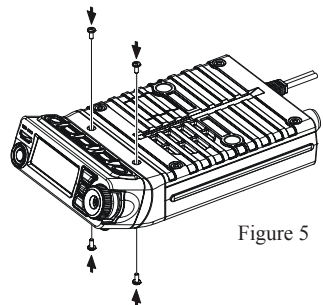

Figure 5



# BASIC OPERATION

## RECEIVE

1. To turn the transceiver on, press and hold in the top panel [POWER] key for two seconds.

When you turn the transceiver on, the applied DC voltage is displayed on the LCD for 2 seconds. Then the operating frequency will be displayed.

To turn the transceiver off, press and hold in the [POWER] key for two seconds.

2. Press the front panel / keys to switch the operating band as follows:

 Key

→ 2 m Amateur Band (H-V) → 430 MHz Amateur Band (H-U) → FM BC Band (FM) → AM BC Band (AM) → WX Band (WX) → Audio Line\* → Group Memory (GRP) → 2 m Amateur Band (H-V) →

 Key

2 m Amateur Band (H-V) → Group Memory (GRP) → Audio Line\* → WX Band (WX) → AM BC Band (AM) → FM BC Band (FM) → 430 MHz Amateur Band (H-U) → 2 m Amateur Band (H-V) →

※ When external audio equipment, like an iPod®, is connected, an after-market cable is required.

When external audio equipment is connected, the input audio level must be adjusted on the external audio equipment.

H-U	430 MHz Amateur Band
H-V	144 MHz Amateur Band
GRP	Group Memory
-	Audio Line
WX	WX Band
AM	AM BC Band
FM	FM BC Band



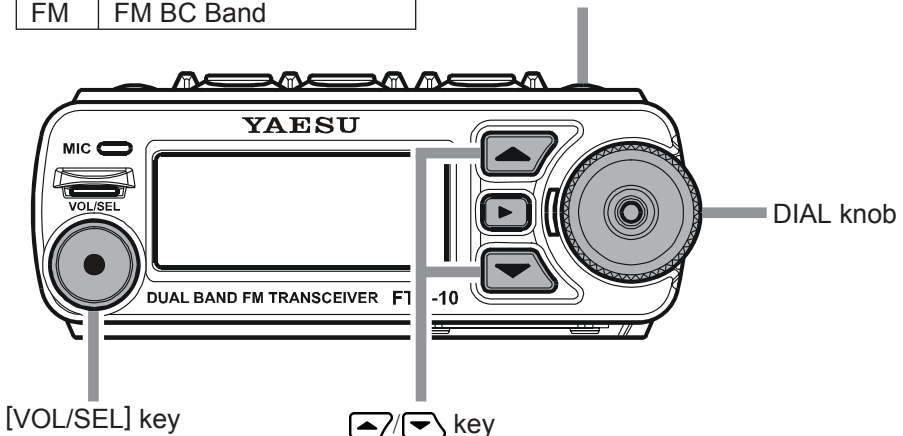

[POWER] key







# BASIC OPERATION



3. Rotating the **DIAL** knob tunes the frequency in pre-programmed steps. Clockwise rotation of the **DIAL** knob will increase the frequency; counter-clockwise rotation will lower the operating frequency.
4. Press and hold in one of the front panel / keys for one second (the 1 MHz digit will blink). Then rotate the **DIAL** knob to change the frequency at 1 MHz per step. This feature is extremely useful for making rapid frequency excursions over the wide tuning range of the **FTM-10R**.
5. Press the [**VOL/SEL**] key until the red LED to the left of the **DIAL** knob illuminates and the volume level is displayed on the LCD. Now, the **DIAL** knob becomes the volume knob.
6. Rotate the **DIAL** knob to adjust the receiver volume. Clockwise rotation increases the audio output level.

## TRANSMISSION

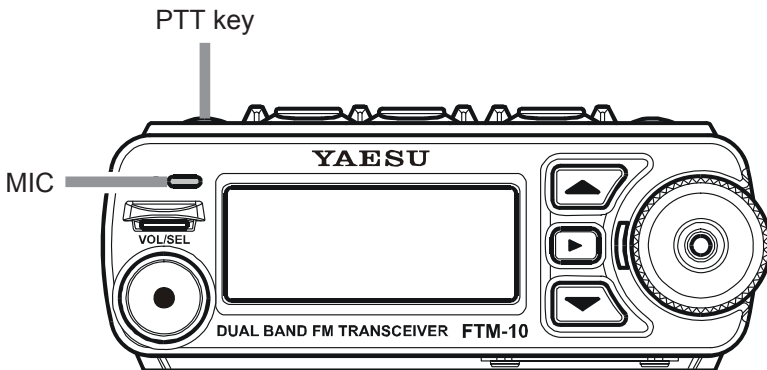







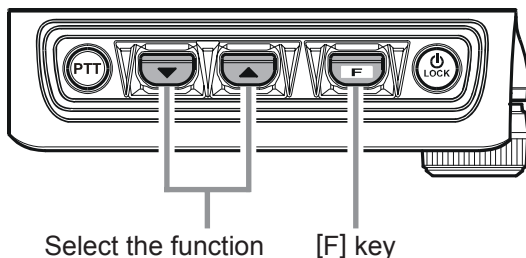



1. Press the front panel / keys to switch the operating band to 144 MHz or 430 MHz band.
2. Press the **PTT** (Push To Talk) key on the front panel when the frequency is clear. Speak into the microphone on the front panel (upper left corner of the front panel) in a normal voice level.  
When talking around 3 feet away from the front panel microphone, the modulation may not be enough and the transmitted audio level may be lower.
3. When your transmission is complete, release the **PTT** key. The transceiver will revert to the receive mode.





# SMART MENU FEATURES

The **FTM-10R** top panel / keys, and the  key select and enable operation of the following features:



Display	Function
AF DUAL	Press the  key to activate the AF Dual function which enables receiving an Amateur Band signal while listening to the signal of an FM Broadcast Station at the same time.
ARTS	Press the  key to activate the ARTS feature.
DIMMER	Press the  key to enable adjustment of the display illumination level by the <b>DIAL</b> knob.
HORN 1	Press the <b>PTT</b> switch to activate the sound of a Gong Bell.
HORN 2	Press the <b>PTT</b> switch to activate the sound of a UFO in flight.
HORN 3	Press the <b>PTT</b> switch to activate the sound of a klaxon.
HORN 4	Press the <b>PTT</b> switch to activate the sound of a siren.
INTERCOM	Press the  key to activate the Intercom mode.
MONI	Press the  key to disable noise and tone squelch.
PA	Press the <b>PTT</b> switch to route your amplified voice through the PA speaker.
REVERSE	Press the  key to activate the Reverse feature.
SCAN	Press the  key to activate the scanner.
SQL LEVEL	Press the  key to enable adjustment of the noise squelch threshold level by the <b>DIAL</b> knob.
SSCH	Press the  key to activate the Smart Search.
TCALL	Press the  key to activate the 1750 Hz Tone Burst.
TX POWER	Press the  key to change the transmit power level.
VOL.ITCOM	Press the  key to change the receiver audio level of the intercom receiver.





**Advice:** When one of the above features does not appear in the list, it is because that feature is not assigned to the top panel / keys. Please insure the Menu “F14 FKEY MOD” is set to “FNC” or “FNC+MSG”.

# SMART MENU FEATURES

## AF DUAL FUNCTION





With the “AF DUAL” function, it is possible to monitor your desired amateur band frequency while receiving AM, FM broadcast or Audio from the external input jack.

You may select: AM broadcast, FM broadcast, Club Channel or external line input, by changing the Menu Item “F2 AF DUAL” (The factory default is AM broadcast receiving).

1. Set the **FTM-10R** to the desired amateur band frequency by the VFO or Memory channel selection.
2. Press the top panel / key to select “AF DUAL”.
3. Press the  key to activate the AF Dual function.
  - By first setting the desired VFO or memory channel in step #1 above, and then starting “AF DUAL” function, both the amateur signals and the AM broadcast station will be received.
4. Rotate the **DIAL** knob to select the desired AM Broadcast station.
  - You may switch the AM Broadcast Band frequency control between the VFO and Memory channel by pressing the  key.
  - When a signal is received in the amateur band, the AM Broadcast audio is muted. When the amateur band signal drops, the AF Dual function is resumed (monitor the amateur band frequency while receiving the AM broadcast).
  - You may transmit on the frequency set in step1 by pressing the **PTT** key, even if the AF Dual function is activated.



To disable the AF Dual function, press the front panel / keys.

- When the  key function is set to “AF DUAL” via the top panel / key, the  key may be used to toggle the “AF DUAL” on/off.



# SMART MENU FEATURES

## ARTS™ (Default “OFF”)

The ARTS feature uses DCS signaling to inform both parties when you and another ARTS equipped station are within communications range. This may be particularly useful during Search and Rescue situations, where it is important to stay in contact with other members of your group.

Both stations must set up their DCS codes to the same code number, then activate their ARTS feature using the command appropriate for their radio. Alert ringers may be activated, if desired.







Whenever you push the **PTT** key, or every 25 seconds after ARTS is activated, your radio will transmit a signal which includes a (subaudible) DCS code for about 1 second. If the other radio is in range, the beeper will sound (if enabled) and the display will show “IN.RANGE”, otherwise the out of range display “OUT.RANGE” will be display during ARTS operation.



Whether you talk or not, the polling every 25 seconds will continue until you de-activate ARTS. When ARTS is de-activated, DCS will also be deactivated (if you were not using it previously in non- ARTS operation).

If you move out of range for more than one minute (four pollings), your radio will sense that no signal has been received. Three beeps will sound, and the display will revert to “OUT.RANGE”. If you move back into range, your radio will again beep, and the display will change back to the “IN.RANGE” indication.



During ARTS operation, your operating frequency will continue to be displayed, but no changes may be made to it or other settings. You must terminate ARTS in order to resume normal operation. This is a safety feature designed to prevent accidental loss of contact due to channel change, etc.

1. Set the **FTM-10R** to the desired amateur band frequency by the VFO or Memory channel selection.
2. Set your radio and the other radio(s) to the same DCS code number per the discussion on page 65.
3. Press the top panel / key to select “ARTS”.
4. Press the  key. You will observe the “OUT.RANGE” display on the LCD. The ARTS operation has now commenced.
5. Every 25 seconds, your radio will transmit a “polling” call to the other station. When that station responds with its own ARTS polling signal, the display will change to “IN.RANGE” to confirm that the other station’s polling code was received in response to yours.
6. When the  key function is set to “ARTS” via the top panel / key, the  key may be used to toggle the “ARTS” on/off.

# SMART MENU FEATURES

## DIMMER FUNCTION





You may adjust the display dimmer level.

1. Press the top panel / key to select “DIMMER”.
2. Press the  key.
3. Rotate the **DIAL** knob to select a comfortable brightness level.





DIMMER 1 ↔ DIMMER 2 ↔ DIMMER 3 ↔  
↔ DIMMER 4 ↔ DIMMER 5  
← Dim Bright →



4. Within two seconds of selecting the brightness level, save the new setting and return to the VFO or Memory Channel mode.  
When the  key function is set to “DIMMER” via the top panel / key, the  key is used as the Dimmer Level control key.

## HORN ALERT FEATURE (Default “OFF”)

The Horn Alert feature outputs one of four unique sounds to the transceiver’s speaker. When an optional **MLS-200-M10** External Speaker is connected, the **FTM-10R** transceiver may be used as an 8 watt Horn Alert.

1. Press the top panel / key to select one of the four functions described below:  
HORN 1: Sounds a Gong Bell.  
HORN 2: Sounds a flight sound of a UFO.  
HORN 3: Sounds a klaxon.  
HORN 4: Sounds an ambulance siren.

2. Press the  key to activate the Horn Alert feature.  
When the Horn Alert function is activated, the volume level graphic will be displayed on LCD.
3. Press the **PTT** key.



- You may change the **PTT** key function via Menu Item “F23 PTT MODE”.  
MOMENT: While pressing the **PTT** key, the audio is output from the speaker (factory default).  
TOGGLE: Once the **PTT** key is pressed the audio is output from the speaker, and when the **PTT** key is pressed once again, the audio output is off.
- The unique sound, which was selected in step 1 above, will be output from the speaker.
- The “HORN OUT” notation appears in the display while the Horn Alert is activated.
- Press the [**VOL/SEL**] key to adjust the volume (AF level) of the Horn Alert output.  
While the RED LED is on, the volume level can be adjusted with the dial knob.
- To disable the Horn Alert feature, repeat steps 1 and 2 above.

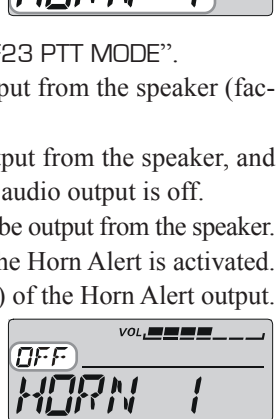

# SMART MENU FEATURES

## INTERCOM FUNCTION

Intercom operation is possible with the **FTM-10R**, by installing the optional **Bluetooth®** Adapter unit “**BU-1**” in the radio and using the optional **Bluetooth®** Headset “**BH-1**”. When operating in a very noisy environment, (for example, a loud exhaust or engine noise, or inside an off-road vehicle) communication with a fellow passenger is possible using the **Bluetooth®** intercom feature.





1. Press the top panel / key to select “INTERCOM”.
2. Press the  key to activate the Intercom function.

When the Intercom function is activated, the volume level graphic will be displayed on LCD.

You may switch the receiver audio volume level between “High” and “Low” via the “VOL.ITCOM” function described below.

When the Intercom function is activated, the internal speakers (front panel and main chassis) are disabled.

To disable the Intercom function, repeat steps 1 and 2 above.

When set the  key function to “INTERCOM” via the top panel / key, the  key to be used as the Intercom feature on/off key.

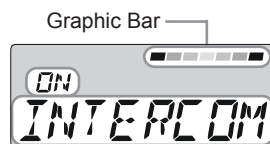

### *Important Notice!*

Use of a sound-isolating headset while driving on public roads is not lawful and hazardous. An open type headset must be used for safety.

## MONITOR FEATURE

The Monitor permits disabling the noise and tone squelch systems temporarily.

When the received signal is weak and the sound from the speaker is intermittent, use this function to over-ride the squelch and hear the received signal.

1. Press the top panel / key to select “MONI”.
2. Press the  key.

The noise and tone squelch are disabled while pressing the  key.

When the  key function is set to “MONI” via the top panel / key, the  key may be used as the “Monitor” key.





# SMART MENU FEATURES

## PUBLIC ADDRESS FEATURE

The Public Address feature enables the output of your voice to the transceiver's speaker.

When an optional **MLS-200-M10** External Speaker is connected, the **FTM-10R** allows the transceiver to be used as an 8 W Public Address system.

1. Press the top panel / key to select "PA".
2. Press the  key to activate the Public Address feature.
3. Press the **PTT** key, and speak into the microphone in a normal voice level.

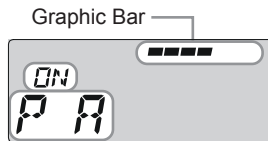

- You may select the **PTT** key function via Menu Item "F23 PTT MODE".

**MOMENT:** While pressing the **PTT** key, the audio is output from the speaker (factory default).

**TOGGLE:** Once the **PTT** key is pressed the audio is output from the speaker, and when the PTT key is pressed once again, the audio output is off.

- Your voice is output to the speaker.
- The "P A" notation appears in the display while the Public Address is activated.
- Press the [**VOL/SEL**] key to adjust the volume (AF level) of the PA output. While the RED LED is on, the volume level can be adjusted with the dial knob.

### CAUTION!

When the function is changed to the radio mode, the volume level remains the same. Please be careful about the volume level setting.

- You may adjust the audio output level by rotating the **DIAL** knob.

To disable the Public Address feature, repeat steps 1 and 2 above.







**Note:** Please be careful that the PA function does not cause any inconvenience or disturbance for others in your area.



## REVERSE FEATURE (Default "OFF" for USA version)

The Reverse feature reverses transmit and receive frequencies while working through a repeater.

It is often helpful to be able to check the uplink (input) frequency of a repeater, to see if the calling station is within direct ("Simplex") range.



1. Press the top panel / key to select "REVERSE".
2. Press the  key to activate the Reverse feature.  
The "" or "" or "" icon will blink while "Reverse" shift is activated.







3. Press the  key again to revert to the "Normal" shift direction.

# SMART MENU FEATURES

## SCAN FEATURE

1. Press the top panel / key to select “SCAN”.
2. Press the  key to initiate upward scanning.  
When the scanner encounters a signal strong enough to open the squelch, the scanner will halt for five seconds, and then resume scanning.





3. To stop the scanner, press the  or **PTT** key.  
When the  key function is set to “SCAN” via the top panel / key, the  key may be used as the scan start/stop command key.  
If you want to change the direction of the scan while it is underway, rotate the **DIAL** knob one click in the opposite direction (in this case, one click counter-clockwise). You will see the scanner reverse direction and scan down in frequency.  
The decimal point of the frequency display will blink while the Scan is activated.  
You may select the Scan Resume mode via the Menu Item “F32 SCN MODE”.  
When you start the scanner in the memory mode, only the memorized memory channels will be scanned

## SMART SEARCH™ OPERATION

The Smart Search feature allows you to load frequencies automatically according to where activity is encountered by your radio. When Smart Search is engaged, the transceiver will search above and below your current frequency, storing active frequencies as it goes (without stopping on them even momentarily). These frequencies are stored into a special Smart Search memory bank, consisting of 31 memories (15 above the current frequency, 15 below the current frequency, plus the current frequency itself). All channels where activity is present will be loaded into the Smart Search memories. The search will stop after one sweep in each direction, whether or not all 31 memories are filled.

### Storing Smart Search Memories

1. Set the radio to the VFO mode. Be sure that you have the Squelch adjusted properly (so that band noise is quieted).
2. Press the top panel / key to select “SSCH”.
3. Press the  key to initiate upward scanning.
4. As active channels are detected, they will automatically be stored into the Smart Search memory bank without causing the sweep to halt.  
If you want to change direction of the Smart Search while it is underway, rotate the **DIAL** knob one click in the opposite direction (in this case, one click counter-clockwise). You will see the scanner reverse direction and Smart Search down in frequency.
5. The Smart Search scan will eventually terminate, and the LCD will revert to Smart Search Memory Channel “<C>”.





# SMART MENU FEATURES

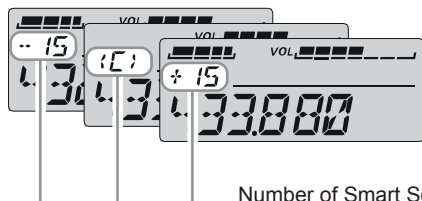

Number of Smart Search Memories.

<C> is the start frequency of the Smart Search.



- To recall the Smart Search memories, just rotate the **DIAL** knob (or press the microphone's [UP]/[DWN] key) to choose from among the Smart Search memories.
- Press the front panel  key to return to VFO mode with the current frequency of the Smart Search memory.

**Note:** 1) Smart Search is a great tool when visiting a city for the first time. You don't need to spend hours looking up repeater frequencies from a reference guidebook. Just ask your **FTM-10R** where the action is!

2) The Smart Search memories are so-called "soft" memories. They will be lost if you initiate a new Smart Search sweep of the band, or if you switch to the VFO or Memory mode.

## SQUELCH LEVEL ADJUST

Adjust the squelch level to mute the noise from the speaker when no signal is being received.

- Press the top panel  key to select "SQL LEVEL".  
The current squelch level will be displayed.
- Press the  key.
- Rotate the **DIAL** knob just to the point where the noise is silenced and the front panel green "BUSY" indicator turns off.

Available selections are:

Amateur Bands:

OFF ↔ MIN ↔ 01 ~ 06 ↔ MAX (Default: 01)

AM/FM Broadcast Bands:

OFF ↔ MIN ↔ 01 ~ 03 ↔ MAX (Default; AM: 01, FM: 02)

If the **DIAL** knob is set further clockwise, sensitivity to weak signals is reduced.

- Press the  key to save the new setting and return to the VFO or Memory Channel mode.

When the  key function is set to "SQL LEVEL" via the top panel  key, the  key may be used as the Squelch Level control key.

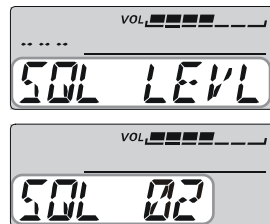





# SMART MENU FEATURES

---

## TCALL (Default “OFF” for USA version)

---

You may enable TCALL if the repeaters in your country require a 1750-Hz burst tone for access.



1. Press the top panel / key to select “TCALL”.
2. Press the  key.  
The transmitter will automatically be activated, and a 1750-Hz audio tone will be superimposed on the carrier.
3. You may release the  key, and use the **PTT** key for activating the transmitter thereafter.

---

## TX POWER SELECT

---

Set the TX Power level to reduce battery drain and use the lowest power necessary to maintain reliable communications.





1. Press the top panel / key to select “TX POWER”.
2. Press the  key repeatedly to select the desired transmit power level.

You may set the transmit power level for the 144 MHz and 430 MHz band individually.



	HIGH	MID	LOW
144 MHz	50 W	20 W	5 W
430 MHz	40 W		









3. Two seconds after selecting the transmitter power level, the new setting is automatically saved and the radio returns to the VFO or Memory Channel mode.  
When the  key function is set to “TX POWER” via the top panel / key, the  key may be used as the Transmit Power Level control key.

---

## INTERCOM VOLUME CONTROL

---

1. Press the top panel / key to select “VOL.ITCOM”.
2. Press the  key to change the Intercom receiver audio volume level between “HIGH” and “LOW”.
3. Two seconds after selecting the Intercom receiver audio volume level, the new setting is automatically saved and the radio returns to the VFO or Memory Channel mode.  
When the  key function is set to “VOL.ITCOM” via the top panel / key, the  key may be used as the Intercom Volume control key.



# MEMORY OPERATION

Many memory resources are available on the **FTM-10R**. A total of 500 memories are available, and each may be appended with an alphanumeric label of up to eight characters, for quick channel recognition.

The **FTM-10R** has two methods of the Memory Mode; (1) Group Memory Mode enables the recall of all memory channels, and (2) In-band Memory Mode enables the recall of memory channels, which are stored in the same operating band.

## MEMORY STORAGE



To store a frequency into memory:

1. Press the front panel / keys to select the desired operating band.
2. Rotate the **DIAL** knob to select the desired operating frequency.
3. Press and hold in the  key for one second.

A “MIN” notation will appear on the display and the frequency display will blink.

After 5 seconds of pressing the  key, will return to the VFO mode.



4. Within 5 seconds of pressing the  key, press the  key again, this time briefly, to store the displayed data into the memory channel slot. The “MIN” notation will disappear (since you are still operating in the VFO mode).

- A “MIN” notation will appear on the display and the frequency display will blink.
- The **FTM-10R** will automatically store the channel frequency and data into the vacant memory channel.
- FTM-10R** can memorize the following items with the frequency at the same time:
  - Memory Group Information
  - Alpha-numeric Memory Channel Tag
  - Repeater Shift (Direction and Shift Frequency)
  - CTCSS/DCS Squelch System and its frequency and code
  - Transmit Output Power Level
  - Scan Mode (Skip Scan or Preferential Scan)
  - Frequency Step
  - Semi-Duplex (Odd) frequency
  - Receiving Mode (AM or FM)

**Important Note:** On rare occasions the memorized data may become corrupted by miss operation, or static electricity. When repairs are made the memory data may be lost. Please write down or record the memorized information so you will be able to restore it if needed.

# MEMORY OPERATION

---

---

## MEMORY RECALL





---

---

Once you have stored the desired memories, you may switch from “VFO” mode to “Memory Recall” mode, and operate on just the stored memory channels.



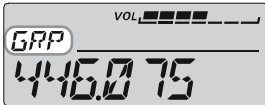





The **FTM-10R** has two methods of recalling the memory. (1) Group Memory Mode enables you to recall all the Memory Channels and (2) In-band Memory Mode enables you to recall only the memory channels which are stored within the same operating band.

### All Memory Channel Recall (Group Memory Mode)

1. To recall the Group Memory bank, press the front panel /  keys until the “GRP” notation appears at the upper left corner in the display for a moment. This indicates that the “Group Memory bank” is now recalled.
- 
2. Rotate the **DIAL** knob to select the desired memory channel. You may recall any of the channels stored in the **FTM-10R** memories.
  3. To exit from the Memory Recall mode, press the front panel /  keys to select the desired operating band.

**Important Note:** The memory channel is assigned to a Group Memory bank automatically. You may assign/eliminate the memory channel to/from the Group Memory bank. See page 36 for details of the operation.

### Recall a memory channel which is stored in the same operating band (In-band Memory Mode)

1. Press the front panel /  keys to recall the desired operating band.  
If you want to recall the 144 MHz band’s memory channel, press the front panel /  keys to recall the “H-V” icon.  
If you want to recall the 430 MHz band’s memory channel, press the front panel /  keys to recall the “H-U” icon.
2. Press the front panel  key briefly. A “MEMORY-” notation will appear on the display for a moment. This indicates that the “Memory Recall” mode is now engaged.
3. Rotate the **DIAL** knob to select the desired memory channel. You may recall a memory channel which is stored in the same operating band of the **FTM-10R**.
4. To exit from the Memory Recall mode, press the front panel  key to return to the VFO mode.

# MEMORY OPERATION

## MEMORY CHANNEL CUSTOMIZATION

The memory channel data can be customized using the following functions.

Example : Select the "M 1 GROUP"

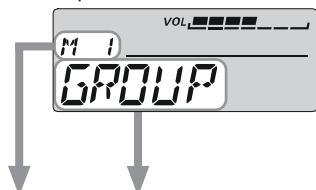

No.	Display	Function
M 1	GROUP	Assigns/Eliminates the memory channel to/from the Memory Group Memory bank.
M 2	MEM CH	Changes the memory channel number to the desired vacant memory channel number.
M 3	MEM SORT	Sorts and renumbers the Memory Channels by frequency, from low to high.
M 4	MEM TAG	Appends an Alphanumeric "Tag" (label) to a memory channel.
M 5	SCN TYPE	Sets the Scan Type (Skip Memory or Preferential Memory).
M 6	SKIPONLY	Set the Preferential Scan List.
M 7	SQL LEVEL	Sets the Squelch Threshold Level.
M 8	SQL TSQF	Change the CTCSS Tone Frequency.
M 9	SQL DCS	Change the DCS Code.
M10	SQL TYPE	Change the Squelch Type (CTCSS or DCS).
M11	TX SHIFT	Stores an independent (in band) transmit frequency (Odd Split).
M12	TX POWER	Change the Transmitter Power Level.
M13	DELETE	Deletes memorized data (except CLUB memory channel).



# MEMORY OPERATION

## MEMORY GROUP BANK

In the **FTM-10R**, the memory channel is assigned to the Group Memory Bank automatically. The Group Memory Bank can be recalled by pressing the front panel  key (A “GRP” notation appears at the upper left corner in the display for a moment.). You may observe the Group Memory Bank between the Audio Line and 2 m Amateur Band.



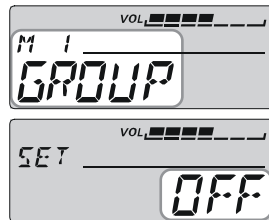

You may assign/eliminate the memory channel to/from the Group Memory Bank. The eliminated memory channel is only recalled by recalling the memory channel, which is stored in the same operating band.

### To eliminate the memory channel from the Group Memory bank:

1. Recall the memory channel you wish to delete from the Group Memory Bank.
2. Press and hold the  key for one second to enter the Memory Channel Customization mode.
3. Rotate the **DIAL** knob to select Menu Item “M1 GROUP”. Press the  key briefly, then rotate the **DIAL** knob to select “OFF”; this deletes the current memory channel from the Group Memory bank.
4. Press the **[VOL/SEL]** key to save the new setting and return to the memory recall mode.







### To re-assign the eliminated memory channel into the Group Memory bank:

1. Press the front panel  key to switch to the VFO mode, if needed.
2. Press the front panel  keys to recall the operating band which is the same band as the eliminated memory channel.
3. Press the front panel  key again to switch to the “Memory Recall” mode, and then rotate the **DIAL** knob to select the memory channel you wish to re-assign into the Group Memory bank.
4. Press and hold the  key for one second to enter the Memory Channel Customization mode.
5. Rotate the **DIAL** knob to select Menu Item “M1 GROUP”.
6. Press the  key briefly, then rotate the **DIAL** knob to select “ON”; the current memory channel will be assigned into the Group Memory bank.
7. Press the **[VOL/SEL]** key to save the new setting and return to the memory recall mode.

# MEMORY OPERATION

## MEMORY CHANNEL NUMBER CHANGE



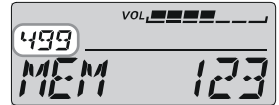

You may change the memory channel number to a desired vacant memory channel manually.

1. Recall the memory channel on which you wish to change the Memory Channel number.
2. Press and hold the  key to enter the Memory Channel Customization mode.
3. Rotate the **DIAL** knob to select Menu Item “M2 MEM CH”.
4. Press the  key briefly. The current memory channel number will appear in the display.
5. Press and hold the  key for one second.
6. Rotate the **DIAL** knob to select the desired memory channel number.  
If you decide to cancel the Memory Channel Number Change, press the [VOL/SEL] key.  
If the channel number is blinking, that channel is currently “occupied” by other frequency data, and you should not select that channel.
7. Press and hold the  key to change the Memory Channel Number.
8. Press the [VOL/SEL] key to save the new setting and return to the memory recall mode.



## MEMORY CHANNEL SORT

You may sort and renumber the Memory Channels by frequency, from low to high:







1. Press the front panel  key to switch to the Memory Recall mode, if needed.
2. Press and hold the  key for one second to enter the Memory Channel Customization mode.
3. Rotate the **DIAL** knob to select Menu Item “M3 MEM SORT”.
4. Press the  key briefly, to display the confirmation message (“SORT Y”) on the LCD.  
If you decide to cancel the Memory Channel Sort, press the [VOL/SEL] key.
5. Press and hold the  key for one second to display the message (“SORTING”) on the LCD, then the **FTM-10R** is reset automatically and sorting is complete.



# MEMORY OPERATION



## LABELING MEMORY

You may wish to append an Alphanumeric “Tag” (label) to a memory or memories, to aid in recollection of the channel’s use (such as a club name, etc.). This is easily accomplished using the Set (Menu) mode.

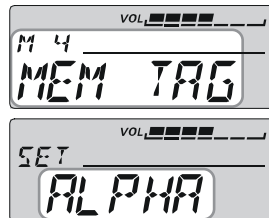
1. Recall the memory channel on which you wish to append a label.
2. Press and hold the  key for one second to enter the Memory Channel Customization mode.
3. Rotate the **DIAL** knob to select Menu Item “M4 MEM TAG”.
4. Press the  key briefly, then rotate the **DIAL** knob to select “ALPHA”.
5. Press and hold the  key for one second to display the previous label.
6. Press the **PTT** key to clear any previous label, if needed.
7. Rotate the **DIAL** knob to select the first digit of the desired label.
8. Press the  key to move to next character.
9. Repeat steps 6 and 7 to program the remaining letters, numbers, or symbols of the desired label. A total of eight characters may be used in the creation of a label.
10. If you make a mistake, press the  key to backspace the cursor, then re-enter the correct letter, number, or symbol.  
Press the **PTT** key to delete all data after the cursor that may have been previously stored erroneously.
11. When you have programmed a label that is under eight characters, press and hold in the  key for one second, until the “ALPHA” notation appears.
12. Press the **[VOL/SEL]** key to save the label and return to the memory recall mode. The label (Alpha-Numeric Tag) will now be displayed.



To disable the Alpha-Numeric Tag (enabling the frequency display):



1. Recall the memory channel on which you wish the frequency to display.
2. Press and hold the  key for one second to enter the Memory Channel Customization mode.
3. Rotate the **DIAL** knob to select Menu Item “M4 MEM TAG”.
4. Press the  key briefly. Then, rotate the **DIAL** knob to select “FREQ”.
5. Press the **[VOL/SEL]** key to return to the memory recall mode. The memory channel frequency will now be displayed.



# MEMORY OPERATION

## SCAN TYPE



The **FTM-10R** has two methods of performing Memory Channel Scan; (1) All Memory Channel Scanning and (2) Scanning only memory channels which are selected via the Skip/Preferential memory setting (see next step).

1. Press the front panel  key to switch to the Memory mode, if needed.
2. Press and hold the  key for one second to enter the Memory Channel Customization mode.
3. Rotate the **DIAL** knob to select Menu Item “M5 SCN TYPE”.
4. Press the  key briefly.
5. Rotate the **DIAL** knob to select desired Scan Type:
  - ALL MEM: The **FTM-10R** scans on all Memory Channels.
  - ONLY MEM: The **FTM-10R** scans only the memory channels that are appended with the “ONLY” flag via the Skip/Preferential memory setting.
6. Press the [VOL/SEL] key to return to the memory recall mode. The memory channel frequency will now be displayed.



## SKIP/PREFERENTIAL SCAN SETTING

The **FTM-10R** allows you to set up a “Preferential Scan List”. You can “flag” channels within the memory system. When you initiate the Preferential Memory Scan, only “flagged” channels will be scanned.



1. Recall the memory channel that you wish to skip. (or Preferential Memory Channel).
2. Press and hold the  key for one second to enter the Memory Channel Customization mode.
3. Rotate the **DIAL** knob to select Menu Item “M6 SKIPONLY”.
4. Press the  key briefly.
5. Rotate the **DIAL** knob to select the desired Scan Type:
  - SKIP: This memory channel is skipped during memory channel scans.
  - ONLY: This memory channel scans during preferential memory scans.
  - OFF: This memory channel scans during memory channel scan.
6. Press the [VOL/SEL] key to return to the memory recall mode. The memory channel frequency will now be displayed.



# MEMORY OPERATION

## SQUELCH LEVEL



The **FTM-10R** allows setting the squelch threshold level.

1. Press the front panel  key to switch to the Memory mode, if needed.
2. Press and hold the  key for one second to enter the Memory Channel Customization mode.
3. Rotate the **DIAL** knob to select Menu Item “M7 SQL LEVL”.
4. Press the  key briefly. Then rotate the **DIAL** knob to select the desired squelch threshold level (“SQL OFF” ~ “SQL MAX”).
5. Press the [VOL/SEL] key to save the new setting and return to the memory recall mode.



## CTCSS FREQUENCY

The **FTM-10R** enables you to change the CTCSS Tone frequency.

1. Recall the memory channel on which you wish to change the CTCSS Tone Frequency.
2. Press and hold the  key for one second to enter the Memory Channel Customization mode.
3. Rotate the **DIAL** knob to select Menu Item “M8 SQL TSQF”.
4. Press the  key to display the current CTCSS Tone Frequency.
5. Rotate the **DIAL** knob to select desired CTCSS Tone Frequency.
6. Press the [VOL/SEL] key to save the new setting and return to the memory recall mode.

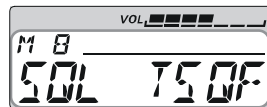



CTCSS TONE FREQUENCY (Hz)									
67.0	79.7	94.8	110.9	131.8	156.7	171.3	186.2	203.5	229.1
69.3	82.5	97.4	114.8	136.5	159.8	173.8	189.9	206.5	233.6
71.9	85.4	100.0	118.8	141.3	162.2	177.3	192.8	210.7	241.8
74.4	88.5	103.5	123.0	146.2	165.5	179.9	196.6	218.1	250.3
77.0	91.5	107.2	127.3	151.4	167.9	183.5	199.5	225.7	254.1

# MEMORY OPERATION

## DCS CODE

The **FTM-10R** enables you to change the DCS Tone Code.



1. Recall the memory channel on which you wish to change the DCS code.
2. Press and hold the  key for one second to enter the Memory Channel Customization mode.
3. Rotate the **DIAL** knob to select Menu Item “M9 SQL DCS”.
4. Press the  key to display the current DCS Code.
5. Rotate the **DIAL** knob to select desired DCS Tone Code.
6. Press the [VOL/SEL] key to save the new setting and return to the memory recall mode.



DCS CODE														
023	047	073	131	156	223	251	271	332	371	445	465	532	631	723
025	051	074	132	162	225	252	274	343	411	446	466	546	632	731
026	053	114	134	165	226	255	306	346	412	452	503	565	654	732
031	054	115	143	172	243	261	311	351	413	454	506	606	662	734
032	065	116	145	174	244	263	315	356	423	455	516	612	664	743
036	071	122	152	205	245	265	325	364	431	462	523	624	703	754
043	072	125	155	212	246	266	331	365	432	464	526	627	712	-

## CTCSS/DCS OPERATION

The **FTM-10R** enables you to change the CTCSS/DCS operation (CTCSS/DCS mode, CTCSS Tone frequency, and DCS Tone Code) that was set previously.

1. Recall the memory channel on which you wish to change the CTCSS/DCS operation.
2. Press and hold the  key for one second to enter the Memory Channel Customization mode.
3. Rotate the **DIAL** knob to select Menu Item “M10 SQL TYPE”.
4. Press the  key to display the current CTCSS/DCS operation mode.



5. Rotate the **DIAL** knob to select desired CTCSS/DCS operation mode.

TONE ENC: Activates the CTCSS Encoder

TONE SQL: Activates the CTCSS Encoder/Decoder

REV TONE: Activates the Reverse CTCSS Decoder (Mutes receiver when matching tone is received)

DCS: Activates the Digital Coded Encoder/Decoder

OFF: Disable the CTCSS/DCS operation

6. Press the [VOL/SEL] key to save the new setting and return to the memory recall mode.





# MEMORY OPERATION

## STORING INDEPENDENT TRANSMIT FREQUENCY (ODD SPLIT)

All memories can store an independent (in band) transmit frequency.





The **FTM-10R** has two methods of the Storing Independent Transmit Frequency; (1) Using the Standard Repeater Shift and (2) Using the Odd Split Memory for operation on repeaters with non-standard shift.

### Using the Standard Repeater Shift

1. Press the  key to enter the memory mode. Then recall the memory channel on which you wish to store the Independent Transmit Frequency.
2. Press and hold the  key for one second to enter the Memory Channel Customization mode.
3. Rotate the **DIAL** knob to select Menu Item “M11 TX SHIFT”.
4. Press the  key briefly.
5. Rotate the **DIAL** knob to select desired shift direction. Available selections are “RPTR -”, “RPTR +”, and “SIMPLEX”.
6. Press the [VOL/SEL] key to save the new setting and return to the memory recall mode. Whenever you recall a memory which contains independently stored transmit and receive frequencies, the “” indication will appear on the display.



### Using the Odd Split Memory



1. In VFO mode, tune to your desired transmit frequency. (Your transmit frequency should be in the same band as the receive frequency).
2. Press the  key to enter the memory mode. Then recall the memory channel on which you wish to store the Independent Transmit Frequency.
3. Press and hold the  key for one second to enter the Memory Channel Customization mode.
4. Rotate the **DIAL** knob to select Menu Item “M11 TX SHIFT”.
5. Press the  key briefly.
6. Rotate the **DIAL** knob to select “S-DUPLEX”.
7. Press the [VOL/SEL] key to save the new setting and return to the memory recall mode. Whenever you recall a memory which contains independently stored transmit and receive frequencies, the “” indication will appear on the display.



# MEMORY OPERATION

## TRANSMITTER POWER LEVEL

The **FTM-10R** enables you to set the Transmitter Power Level for each memory channel individually.



1. Recall the memory channel on which you wish to set the Transmitter Power Level.
2. Press and hold the  key for one second to enter the Memory Channel Customization mode.
3. Rotate the **DIAL** knob to select Menu Item “M12 TX POWER”.
4. Press the  key briefly to display the current Transmitter Power Level.
5. Rotate the **DIAL** knob to the select desired Transmitter Power Level (“LOW”, “MID”, or “HIGH”).
6. Press the **[VOL/SEL]** key to save the new setting and return to the memory recall mode.



	HIGH	MID	LOW
144 MHz	50 W	20 W	5 W
430 MHz	40 W		

## DELETING MEMORY

You may delete the memorized data (except CLUB memory channel) of the **FTM-10R** memories.

1. Recall the memory channel on which you wish to delete.
2. Press and hold the  key for one second to enter the Memory Channel Customization mode.
3. Rotate the **DIAL** knob to select Menu Item “M13 DELETE”.
4. Press the  key briefly to display the confirmation message (“DELETE Y”) on the LCD.

If you decide to cancel the Erasure of Memory Data, press the **[VOL/SEL]** key.

5. Press and hold the  key for one second. The display will revert to memory mode.

**Note:** Once deleted, the channel data can not be recovered.



# CLUB CHANNEL OPERATION

The **FTM-10R** has a special memory channel called “Club Channel”, and the following features can be handy.

The “Club Channel” is displayed at the first of the Group Memory Bank and “CLB” is indicated when the channel is recalled. The Club Channel can also be reprogrammed.



Monitoring the “Club Channel” periodically. (Club Channel Monitor function)  
There are two (2) methods for this feature.

1. While monitoring the other memory channel, periodically checking the “Club Channel”. (See below)
2. While listening to the AM or FM broadcast stations or the external audio input signal, periodically checks the “Club Channel”. (See page 62)

Message transmission function (See page 46)

Duplicate the memorized messages and the ID of the members registered in the radio. (Message Clone function. See page 48)

Duplicate the memory channel and other setting information to other radios. (Clone function. See page 50)

## Recalling the Club Channel

1. Press the front panel / key to recall the Group Memory Bank (“GRP” notation will appear at the upper left corner in the display for a moment).



When the display indicates the Clock, Stop Watch Timer, or Temperature, press the [VOL/SEL] key to change to the VFO or memory mode, then perform the above selection.

2. Rotate the **DIAL** knob to select the Club Channel (The “CLB” notation will appear at the upper left corner in the display for a moment, then change to “GRP” notation).



You may change the Club channel frequency to your desired frequency.

## Activating the Club Channel Monitor

This function monitors the “Club Channel” periodically once each 3 seconds while listening to another memory channel or a VFO frequency. Once a signal is received on the “Club Channel”, the **FTM-10R** automatically receives the “Club Channel” signal continuously until the signal disappears.

**Note:** The “Club Channel” is only watched once per 3 seconds, and a signal sent on the “Club Channel” may be missed. If the “Club Channel” needs to be monitored with higher priority, this mode is not recommended. Please note that while listening to the AM or FM broadcast band or the external audio input signal, the “Club Channel” is

# CLUB CHANNEL OPERATION

watched periodically, and the signal on the “Club Channel” is received.

When “Club Channel” function is activated, a noise may be heard every time the “Club Channel” is watched (once per 3 seconds). This noise is caused by checking the “Club Channel” for any signals. This is not a problem or defect of the radio.

1. Press and hold the [VOL/SEL] key for one second to activate the Menu mode.  
If the display indicates the Clock, Stop Watch Timer, or Temperature, press the [VOL/SEL] key and change to the VFO or memory mode, then perform above step.
2. Rotate the **DIAL** knob to select Menu Item “F10 CLUB PRI”.
3. Press the  key to enable selection of this Menu Item.
4. Rotate the **DIAL** knob to select the desired operating mode:



**AUTO:** The **FTM-10R** checks the “Club Channel” each 3 seconds. When a signal is received on the “Club Channel”, the **FTM-10R** will monitor the channel until the signal drops. When the signal drops, the

**FTM-10R** will resume checking the “Club Channel” each 3 seconds.

**HOLD:** When a signal is received on the “Club Channel”, the **FTM-10R** receives the “Club Channel” continuously, and will not restart the “Club Channel” monitor.

**OFF:** Disables the Club Channel Monitor feature.

5. Press the [VOL/SEL] key for one second to save the new setting and activate Club Channel Monitor.

When the Club Channel Monitor is activated, the “**PRI**” icon will appear (if receiving on the VFO or memory channel) or blink (if receiving on the “Club Channel”) on the display.

When the **PTT** key is pressed, the **FTM-10R** will transmit on the “Club Channel”.

You may change the VFO frequency or memory channel while Club Channel Monitor is active.

6. To disable the Club Channel Monitor, select “OFF” as in step 4 above.

Return to the VFO or Memory Channel mode.

When the “AUTO” mode is selected in step 4 above, press the  key to return to the VFO or Memory Channel mode while receiving the “Club Channel”.

The difference between “Club Channel Monitor” and “AF DUAL” feature.

- (1) The “Club Channel Monitor” feature watches a club channel every 3 seconds while you are listening to an AM/FM broadcast station or an amateur band signal.
- (2) The “AF DUAL” feature always receives the Club channel, even if you are listening to the AM/FM broadcast band, audio or an amateur band signal. Two receivers are included. One is for AM/FM reception and the other is for the amateur bands. You will never miss a signal on the Club Channel, ever.

# MESSAGE FEATURE





While operating on the Club Channel, a message (up to 16 characters) can be sent, instead of sending a voice. 20 kinds of messages can be programmed, and one of them can be selected and transmitted with your ID.

**Note:** The Message Feature requires that all members (1) use the **FTM-10R** transceiver, (2) store the same messages into the message slot, (3) store the same member list into the member box, and (4) store the desired coordination frequency into the “Club Channel”. The Message Feature does not send the Message through the repeater. The Message Feature is not active when the CTCSS, DCS, or Pager is activated.

## PROGRAMMING A MESSAGE

(Requires all members to set the same message into the same message slot in the same order.)

The **FTM-10R** has 20 message slots, including a factory-programmed message (EMERGENCY). The factory-programmed message of course can be overwritten at any time with personalized messages.

1. Press and hold the [VOL/SEL] key for one second to activate the Menu mode. When the display indicates the Clock, Stop Watch Timer, or Temperature, press the [VOL/SEL] key to change to the VFO or memory mode, then perform the above.
2. Rotate the **DIAL** knob to select Menu Item “F18 MESSAGE”.
3. Press the  key to enable selection of this Menu Item.
4. Rotate the **DIAL** knob to select the desired Message slot into which you wish to store a message. The LCD displays the previously stored message.
5. Press and hold the  key for one second. Press the **PTT** key to clear the previously stored message, if desired.
6. Rotate the **DIAL** knob to select the first character of the message you wish to store, and then press the  key briefly to save the first character of the message and move on to the next place.
7. Repeat the previous step to complete the message (up to 16 characters). If you make a mistake, press the  key to move back to the incorrect character, then re-enter the correct character. Press the **PTT** key to delete all data after the cursor that may have been previously stored erroneously.
8. When the Message entry is complete, press and hold in the  key for one second. If you decide to cancel programming a message, press the [VOL/SEL] key to exit to normal operation.
9. If you wish to store another message, repeat steps 4 through 8 above.
10. Press the [VOL/SEL] key to save the new setting and exit to normal operation.

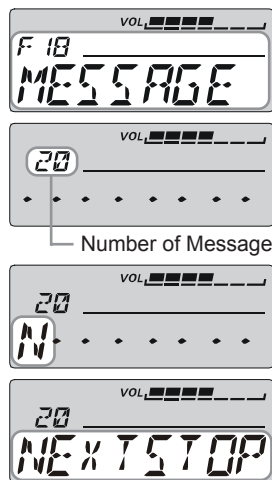



# MESSAGE FEATURE

## PROGRAMMING A MEMBER LIST





(Requires all members set the same member list (includes own ID) into the same member box in the same order.)

It is possible to register a maximum of 20 persons, in order to identify the sender. When you receive a message transfer, you can know who sent the message by the ID in the register. In addition, your ID can be sent to the members when you transmit any messages to them.

If all the members share the register information (ID), the message sender ID will be shown on the display when receiving the message.

Even if no IDs are registered, the function can work. In this case “MEMBER 1” though “MEMBER 20” will be displayed, when receiving a message.

We recommend that you use your call sign for the member list.

1. Press and hold the [VOL/SEL] key for one second to activate the Menu mode.  
When the display indicates the Clock, Stop Watch Timer, or Temperature, press the [VOL/SEL] key to change to the VFO or memory mode, then perform the above step.
2. Rotate the **DIAL** knob to select Menu Item “F16 ID LIST”.
3. Press the  key to enable selection of this Menu Item.
4. Rotate the **DIAL** knob to select the desired member box (1 ~ 20) into which you wish to store a member ID. The LCD will display the previously stored member ID.
5. Press and hold the  key for one second.  
Press the **PTT** key to clear the previously stored member ID, if desired.
6. Rotate the **DIAL** knob to select the first character of the personal ID you wish to store, and then press the  key briefly to save the first character of the personal ID and move on to the next place.
7. Repeat previous step to complete the personal ID (up to 8 characters). If you make a mistake, press the  key to move back to the incorrect character, then re-enter the correct character.  
Press the **PTT** key to delete all data after the cursor that may have been previously stored erroneously.
8. When the personal ID entry is complete, press and hold in the  key for one second.  
If you decide to cancel programming a member ID, press the [VOL/SEL] key, exit to normal operation.
9. If you wish to store another personal ID, repeat steps 4 through 8 above.
10. Press the [VOL/SEL] key to save the new setting and exit to normal operation.



Number of Member box

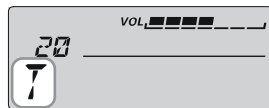

# MESSAGE FEATURE

## CLONING THE MESSAGE

It is possible to copy/duplicate the programmed messages, and all the IDs of the members, when using the “Message” function.

If messages (max 20 messages) and IDs (max 20 persons) are programmed in only one transceiver (**FTM-10R**), the information can be copied to the transceivers of all members at once, without connecting any cables.

**Note:** This message clone function will only operate using the Club Channel frequency in the 440 MHz amateur band.

Recall and monitor the Club Channel frequency. If the channel is busy and any signal is heard, the message clone function cannot work correctly. Change the Club Channel to a frequency not in use, and clone the messages and the IDs.

### Preparations (Source Transceiver)

1. Turn the transceiver off.
2. Press and hold the **PTT** key while turning the power on again.
3. The “TX CLONE” notation and the Club Channel frequency appear on the display alternately.



### Preparations (Destination Transceiver)

1. Turn the transceiver off.
2. Press and hold the [VOL/SEL] key while turning the power on again.
3. Rotate the **DIAL** knob to select the “SF2 COPY MSG”.



### Cloning

1. Bring the Source Transceiver and the Destination Transceiver as close as possible.
2. Press the top panel  key on the Source Transceiver.

The Destination Transceiver does not require any set up operation.

When receiving clone data from the “Source Transceiver”, the “Destination Transceiver” automatically stores all the data. The LED blinks for 3 seconds with a blue color, then displays “MSG” and “RECEIVED” on the LCD. The “Destination Transceiver” automatically turns off and on, then returns to normal operation and mode set before the Clone operation began. The copy/clone procedure is completed.

After completion of the copy/cloning, set your “MY ID” (see page 49). By setting the “MY ID”, your ID will be displayed with the messages you send.

If “ERROR” is displayed on the LCD screen during the Clone procedure, the cloning has not completed correctly. In this case, first turn the radio off and back on, then try the cloning procedure again. In this case, please be aware of the following advice.

- The distance between the source transceiver and destination transceiver must be close.
- Signals on the Club Channel frequency may interrupt the data transfer.
- Any equipment that generates electrical noise may interrupt the data transfer.

# MESSAGE FEATURE

## SET YOUR PERSONAL ID

To choose your personal ID from the member list.

1. Press and hold the [VOL/SEL] key for one second to activate the Menu mode.  
When the display indicates the Clock, Stop Watch Timer, or Temperature, press the [VOL/SEL] key to change to the VFO or memory mode, then perform the above step.
2. Rotate the **DIAL** knob to select Menu Item “F17 ID REG”.
3. Press the  key to enable selection of this Menu Item.
4. Rotate the **DIAL** knob to select the member box (1 ~ 20) where your ID is stored.
5. Press the [VOL/SEL] key to save the new setting and exit to normal operation.

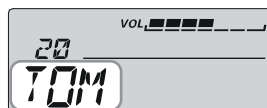

## SENDING MESSAGES

The registered message can be sent to the members who are receiving the Club Channel.

When a message is sent, the transmitter's ID will be sent also, and the receiver can identify who sent the message.



**Note:** This “Message” function is only available on the Club Channel.

The “MY ID” setting (see above) is required for the transmitter's ID to be shown with the received message.

1. Press and hold the [VOL/SEL] key for one second to activate the Menu mode.  
When the display indicates the Clock, Stop Watch Timer, or Temperature, press the [VOL/SEL] key to change to the VFO or memory mode, then perform above step.
2. Rotate the **DIAL** knob to select Menu Item “F14 FKEY MOD”.
3. Press the  key to enable selection of this Menu Item.
4. Rotate the **DIAL** knob to set this Menu Item to “FNC+MSG” or “MSG” (this will enable the selection of the transmit message with the top panel keys).
5. Press the [VOL/SEL] key to save the new setting and exit to normal operation.





### To send a message:

1. Press the front panel / to recall the Group Memory Bank (the “GRP” notation will appear at the upper left corner in the display for a moment).
2. Rotate the **DIAL** knob to select the Club Channel (The “CLB” notation will appear at the upper left corner in the display for a moment).



# MESSAGE FEATURE

When the Club Channel monitor feature is activated, steps 1 and 2 above are not necessary.





3. Press the top panel  or  key to select the message you wish to send.
4. Press the top panel  key to transmit the selected message on the Club channel frequency.

The “TXM” notation will appear on the display, and the message will be transmitted. It takes approximately 8 seconds to transmit the message.

When the message transmission is completed, the TX/BUSY indicator glows white for one second.



## Receiving a Message

1. To receive a message, press the front panel  or  key to recall the Club channel or activate the Club Channel monitor feature (see page 44).
2. When you receive a message: a beep sounds, the TX/BUSY indicator blinks blue, and [“Message” from “sending station’s ID”] scrolls on the display.  
Press the , , or  key to clear the received message, and wait for a new message.

---

## CLONING

---

You can transfer messages or all data stored in one **FTM-10R** to another **FTM-10R** by utilizing the handy “Cloning” feature. The **FTM-10R**’s Clone feature uses the radio link. No hardwire connection is needed.

**Note:** The clone function is realized only by using the Club Channel frequency of 440 MHz amateur band. Recall and monitor the frequency of the Club Channel. If the channel is busy (some person is using the frequency and any signal is heard), the message clone function will not work correctly. In this case, change the Club Channel frequency. See page 52 for details.

## Preparations (Source Transceiver)

1. Turn the transceiver off.
2. Press and hold the **PTT** key while turning the power on again.  
The “TX CLONE” notation and the Club Channel frequency appear on the display alternately.



## Preparations (Destination Transceiver)

1. Turn the transceiver off.
2. Press and hold the [VOL/SEL] key while turning the power on again.
3. Rotate the **DIAL** knob to select the “SF1 COPY ALL”.



# MESSAGE FEATURE

## Cloning

1. Bring the Source Transceiver and the Destination Transceiver as close to each other as possible.
2. Press the top panel's **PTT** key on the Source Transceiver. While transmitting the clone data, the Source Transceiver's LED blinks red and blinks the "SENDING" notation on the LCD.



When clone data has finished transmitting, the Source Transceiver's LED blinks white for around 3 seconds and then displays "ALL" and "SENT OUT" on the LCD. Then, the "TX CLONE" notation and the Club Channel frequency appears on the display alternately again.



To finish the Cloning, turn the radio off by pressing and holding the [**POWER**] key for two seconds.

3. The Destination Transceiver does not require any set -up operation.
4. When receiving cloning data from the "Source Transceiver", the "Destination Transceiver" automatically stores all the data, and the LED blinks white for 3 seconds, then displays "ALL" and "RECEIVED" on the LCD. Then, the "Destination Transceiver" turns off automatically, and turns on again. The radio returns to normal operation in the VFO or memory mode, as before the Clone operation began. The copy/clone procedure is completed.



If "ERROR" is displayed on the LCD screen while doing the Clone procedure, the cloning process was not successful. In this case, turn the radio off and retry the cloning procedure. In the case of repeated cloning failures, see the following information.

The distance of the transceivers (source transceiver and Destination Transceiver) has to be close.



Check any equipment in the area that may be generating electrical noise. This may interrupt data transfer.

# MESSAGE FEATURE

## CHANGING THE CLUB CHANNEL FREQUENCY

By factory default, the 439.900 MHz (EXP Version:433.500 MHz) frequency is stored in the Club Channel. If you wish to change the Club Channel, perform the following steps.

**ADVICE:** For the “Club Channel”, any frequency in the 144 MHz or 440 MHz amateur bands can be programmed. However, the Message Clone function and the Clone function can work only on the 440 MHz band. When these functions are used, select the 440 MHz band.

1. Press the front panel / key to recall the Group Memory Bank (“GRP” notation appears at the upper left corner in the display for a moment).



When the display indicates the Clock, Stop Watch Timer, or Temperature, press the [VOL/SEL] key to change the VFO or memory mode, then perform the above selection.

2. Rotate the **DIAL** knob to select the Club Channel (The “CLB” notation appears at the upper left corner in the display for two seconds, then changes to the “GRP” notation).



3. Press and hold the  key for one second to enter the Club Channel Customization mode.

4. Rotate the **DIAL** knob to select Menu Item “C1 CLUB FRQ”.
5. Press the  key momentarily, to display the current memorized frequency of the Club Channel and the “SET” notation will be blinking.



6. Press and hold the  key for one second to enable the changing of the Club Channel frequency.

The blinking “SET” notation changes to the blinking “CLB” notation.

7. Rotate the **DIAL** knob to select the desired Club Channel frequency.

You may change the operating band (430 MHz to 144 MHz, or vice versa) by pressing the front panel / keys.

8. Press and hold the  key for one second to save the new Club Channel frequency. The blinking “CLB” notation returns to the blinking “SET” notation.
9. Press the [VOL/SEL] key to save the new setting and exit to normal operation.







# CLOCK/TIMER OPERATION

The **FTM-10R** has a 24-hour clock (accuracy:  $\pm 30$  sec/month).

With the Clock/Timer, you may operate the following features:

- Clock feature: Display the current time.
- Stop Watch Timer feature.

## SET UP THE CLOCK

1. Press and hold the [VOL/SEL] key for one second to activate the Menu mode.
2. Rotate the **DIAL** knob to select Menu Item “F9 CLOCK”.
3. Press the  key to enable selection of this Menu Item.
4. Rotate the **DIAL** knob to select “ON”.
5. Press the [VOL/SEL] key to save the new setting and exit to normal operation.
6. Press the [VOL/SEL] key repeatedly to display the Clock, Stop Watch Timer, or Thermometer.
7. Rotate the **DIAL** knob to select the Clock.  
When the Clock is displayed in above step, this step is unnecessary
8. Press and hold the [VOL/SEL] key for one second to activate the Clock/Timer Customization mode.
9. Rotate the **DIAL** knob to select Menu Item “T1 TIME ADJ.”
10. Press the  key to display the current time.
11. Press and hold the  key. You will notice the “hour” column blinking. Rotate the **DIAL** knob to set the exact current hour.
12. Press the  key to move the blinking column to “minute”. Rotate the **DIAL** knob to set the exact current minute.
13. Press the  key to save the new setting.  
When the  key is pressed in accordance with the time signal from a radio station etc, the **FTM-10R**'s clock may be set more precisely.
14. Press the [VOL/SEL] key to exit to normal operation.

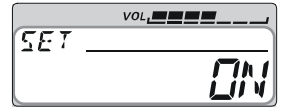

# CLOCK/TIMER OPERATION

## DISPLAYS THE CURRENT TIME

### Activate the Clock

1. Press and hold the [VOL/SEL] key for one second to activate the Menu mode.
2. Rotate the **DIAL** knob to select Menu Item “F9 CLOCK”.
3. Press the  key to enable selection of this Menu Item.
4. Rotate the **DIAL** knob to select “ON”.

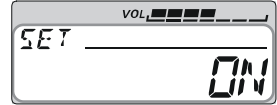

### Display the Clock

1. Press the [VOL/SEL] key repeatedly to display the Clock, Stop Watch Timer, or Thermometer.
2. Rotate the **DIAL** knob to display the Clock.

When the Clock is already displayed in the above step, this step is unnecessary



You may change the setting of the **DIAL** knob, so it does not return automatically to the Frequency Select dial function.

- Press and hold the  key for one second to reset the “Minute” and “Second” clock display to “00”.

#### *Example 1*

“XX:00:00” ~ “XX:29:59” to reset to “XX:00:00”

“10:29:59”  “10:00:00”

#### *Example 2*

“XX:30:00” ~ “XX:59:59” to reset to “XX+1:00:00”

“10:49:49”  “11:00:00”

- You may change the time system via the Menu Item “T4 12H/24H”. Available selections are “12H” and “24H”
- You may change the clock format via the Menu Item “T3 T FORMAT”. Available selections are “HH:MM:SS”, “HH:MM”, and “MM:SS”.
- The accuracy of the clock on this radio is 30 seconds per month under the normal temperature. This accuracy depends on the temperature fluctuations in the place where the radio is used.
- The clock has a back-up Lithium battery, and will function for around 2 months after disconnecting the power supply cable.





# CLOCK/TIMER OPERATION

## USING THE STOP WATCH TIMER

The Stop Watch provides several timing functions for your convenience at motor sports and rallies.



To operate the Stop Watch Timer, first activate a Clock function via the Menu mode “F9 CLOCK”.

1. Press the [VOL/SEL] key repeatedly to display the Clock, Stop Watch Timer, or Thermometer.
2. Rotate the **DIAL** knob to display the Stop Watch Timer.  
This step is not necessary if the Stop Watch Timer is displayed in the above step.
3. The Stop Watch Timer is designed to Start and Stop repeatedly whenever you press the  key. The LED at the left of the **DIAL** knob blinks yellow while the Stop Watch Timer is counting.
4. Press and hold the  key for one second to reset the Stop Watch Timer.



## USING THE INTERVAL TIMER

The Interval timer is similar to the Stop Watch Timer. It is synchronized with the Stop Watch Timer. To operate the Interval Timer, First activate a Clock function via the Menu mode “F9 CLOCK”.

1. Press the [VOL/SEL] key repeatedly to display the Clock, Stop Watch Timer, or Thermometer.
2. Rotate the **DIAL** knob to display the Interval Timer.  
This step is not necessary if the Stop Watch Timer is displayed in the above step.
3. The Interval Timer (and Stop Watch Timer) is designed to Start and Stop repeatedly whenever you press the  key. The LED at the left of the **DIAL** knob blinks yellow while the Interval Timer is counting.  
Press and hold the  key for one second to reset both the Interval Timer and Stop Watch Timer.



# CONVENIENCE FEATURES

## MUTE FEATURE

Press and hold the [VOL/SEL] key for one second to mute the receiver audio volume temporarily, without touching the volume (DIAL) knob. (The **FTM-10R** will shift to the Menu mode)

To disable the MUTE feature, press the [VOL/SEL] key momentarily.

## LOCK

Press the [POWER] key momentarily while the transceiver is turned on, the key lockout feature is activated, to prevent accidental frequency change.

The “LOCK” notation appears on the display for one second.

To unlock the key, press the [POWER] key again.

The “UNLOCK” notation appears on the display for one second.

You may also lock out the **PTT** key when the LOCK mode is activated via the Menu Item “F22 PTT LOCK”. See page 87.



## AUTOMATIC AUDIO VOLUME CONTROLLER

The **FTM-10R** includes an Automatic Audio Volume Controller to allow the most comfortable and/or effective reception in noisy environments. To activate the Automatic Audio Volume Controller:

1. Press and hold the [VOL/SEL] key for one second to activate the Menu mode.
2. Rotate the **DIAL** knob to select Menu Item “F1 AF AUTO”.
3. Press the  key to enable selection of this Menu Item.
4. Rotate the **DIAL** knob to select the desired effect level.



ON MIN: Activates the Automatic Audio Volume Controller with the low effect level.

ON MID: Activates the Automatic Audio Volume Controller with the medium effect level.

ON MAX: Activates the Automatic Audio Volume Controller with the high effect level.

OFF: Disable the Automatic Audio Volume Controller.



5. Press the [VOL/SEL] key to save the new setting and exit to normal operation.

# CONVENIENCE FEATURES

## AF-VFO FEATURE

By default, the volume control (**DIAL** knob) and Clock display do not return to the frequency control automatically when you leave an interval of approximately three seconds. You may change the status of the **DIAL** knob so that the display will return automatically to the Frequency select dial function and Frequency display.

1. Press and hold the [VOL/SEL] key for one second to activate the Menu mode.
2. Rotate the **DIAL** knob to select Menu Item “F5 AF-VFO”.
3. Press the  key to enable selection of this Menu Item.
4. Rotate the **DIAL** knob to select the desired mode.

**TOGGLE:** Keeps the **DIAL** knob function and display until the [VOL/SEL] key is pressed once again.

**AUTOBACK:** The **DIAL** knob function and display comes back to frequency selection and frequency display approximately three seconds after.

Press the [VOL/SEL] key to save the new setting and exit to normal operation.

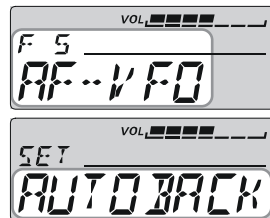

## VOX OPERATION

The VOX system provides automatic transmit/receive switching based on voice input to the microphone. With the VOX system enabled, you do not need to press the **PTT** key in order to transmit.

1. Press and hold the [VOL/SEL] key for one second to activate the Menu mode.
2. Rotate the **DIAL** knob to select Menu Item “F46 VOX MIC”.
3. Press the  key to enable selection of this Menu Item.
4. Rotate the **DIAL** knob to select the one of the following microphone functions.

**R-HAND:** Enable the VOX operation for the microphone which is connected to the rear panel MIC Jack.

**F-HAND:** Enable the VOX operation for the microphone which is connected to the front panel MIC Jack.

**FRONT:** Enable the VOX operation for the front panel microphone.

**VOX OFF:** Disable the VOX operation.

5. Press the [VOL/SEL] key to save the new setting and exit to normal operation.

To disable the VOX operation, just repeat the above procedure, rotating the **DIAL** knob to select “VOX OFF” in step 4 above.

- If the VOX feature is activated by background noise, adjust the VOX gain via the Menu Item “F47 VOX SENS”. See page 58 for details.
- When the transceiver audio is output to the speaker, the VOX will not activate the transmitter even if you talk directly into the microphone.

# CONVENIENCE FEATURES

---

## VOX SENSITIVITY



---

You may select the VOX sensitivity.

1. Press and hold the [VOL/SEL] key for one second to activate the Menu mode.
2. Rotate the **DIAL** knob to select Menu Item “F47 VOX SENS”.
3. Press the  key to enable selection of this Menu item.
4. Rotate the **DIAL** knob to select the desired sensitivity.  
Available selections are “NORMAL”, “HIGH”, and “MAX”.
5. Press the [VOL/SEL] key to save the new setting and exit to normal operation.

## LISTENING THE AM/FM BROADCAST STATION

---

1. Press the front panel / keys to switch the operating band to AM or FM.
2. Rotate the **DIAL** knob to select desired Broadcast station.
  - When a signal is weak and difficult to hear, in some cases you may be able to hear better by adjusting the squelch via the Menu Item “F38 SQL LEVEL”. See page 31 for details.
  - When using the optional **BH-1** Bluetooth® Headset with the **FEP-4** Ear Phone or an after-market stereo speaker, you may enjoy stereo listening from the FM Stereo Broadcast Station or External Audio Input via the Menu Item “F42 STEREO”. See page 87 for details.
  - You may adjust the receiver audio responses via the Menu Item “F3 AF PITCH”. See page 85 for details.
  - You may set the Automatic Audio Volume Controller to allow the most comfortable and/or effective reception in noisy environments via the Menu Item “F1 AF AUTO”. See page 56 for details.
  - You may set the Volume Setting Alert feature via the Menu Item “F4 AF PRESET”. See page 86 for details.

**Note:** When receiving AM Broadcast stations, the receive sensitivity may be poor when using an antenna designed with a matching system that is a low DC impedance between the center and shield of the coax. For better AM reception, use an antenna that does not present a low DC resistance to ground.

## TIME-OUT TIMER (TOT)

---



The **FTM-10R** has the “Time-Out Timer” (TOT) feature that is designed to force the transceiver into the “receive” mode after a preset time of continuous transmission (the default is “OFF”). This feature prevents your transceiver from transmitting a “dead carrier” for a long time if the microphone **PTT** switch is accidentally locked in the “TX” condition. The Time-Out Timer “switch-to-receive” time may be adjusted from 1 to 30 minutes, or Off via Menu Item.



1. Press and hold the [VOL/SEL] key for one second to activate the Menu mode.
2. Rotate the **DIAL** knob to select Menu Item “F43 TOT”.
3. Press the  key to enable selection of this Menu Item.
4. Rotate the **DIAL** knob to select the desired interval. Available selections are 1 to 30 minutes, or Off.
5. Press [VOL/SEL] key to save the new setting and exit to normal operation.

When your transmission time is within 10 seconds of the Time-Out Timer expiration, an alert bell will provide an audible warning from the speaker.

# ***LISTENING TO EXTERNAL AUDIO INPUT***

The **FTM-10R** enables you to output the audio signal from the external audio equipment such as an iPod® to the speaker. You may operate on the amateur band while listening to your favorite music.

1. Turn off the **FTM-10R** and external audio equipment.
2. Connect the external audio equipment to the LINE IN Jack on the rear panel of the **FTM-10R**.
3. Turn on the **FTM-10R** by pressing and holding the [**POWER**] key for two seconds.
4. Press the front panel / key to select the “LINE-IN” band.
5. Turn on the external audio equipment.
  - Press the [**VOL/SEL**] key to adjust the volume (AF level) of the audio output level. While the RED LED is on, the volume level can be adjusted with the dial knob.
  - The volume level is displayed on the LCD.
  - Adjust the audio input level at the external audio equipment side.
  - You may monitor the amateur band and external audio signal at the same time when you activate the Club Channel Monitor function.
  - You may enjoy stereo listening from external audio Input. Use the optional BH-1 **Bluetooth**® Headset with the **FEP-4** Ear Phone for **BH-1** or an aftermarket stereo speaker, and set the Menu Item “F42 STEREO”. See page 87 for detail.

When you have finished listening to the external audio, press front panel / key to select another band.

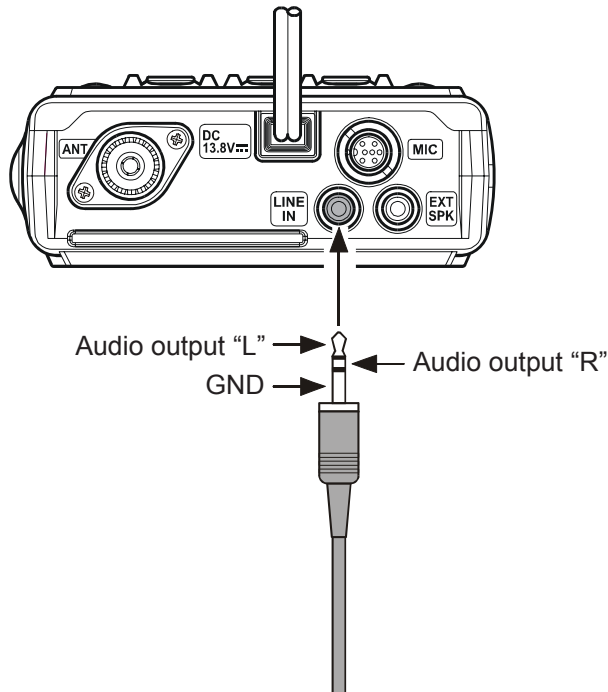

# Bluetooth® OPERATION

Installation of the optional **BU-1 Bluetooth®** Adapter Unit will enable, the **FTM-10R** to send/receive voice messages with the optional **BH-1 Bluetooth®** Headset via wireless links.

## Pairing

When using the **Bluetooth®** Headset for the first time, the **Bluetooth®** Headset and the **FTM-10R** must be paired.

○ Bring the **Bluetooth®** Headset and the **FTM-10R** close together when doing Pairing.

1. Turn the transceiver off.
2. Press and hold the [VOL/SEL] key while turning the power on again.
3. Rotate the **DIAL** knob to select the **Bluetooth®** Adapter Unit you wish to pair.

Main Chassis **Bluetooth®** Adapter Unit:

Menu Item “SF6 BLTH R”



Front Panel **Bluetooth®** Adapter Unit:

Menu Item “SF7 BLTH F”





4. Press the **PTT** key.

The default PIN code (6111) appears.

You may change the PIN code, if desired, before continuing with step 5.



1. Press the **PTT** key, and then rotate the **DIAL** knob to set the first digit of the PIN code.
  2. Press the  key to save the first digit of the PIN code and move on to the next place.
  3. Repeat the previous steps to complete the PIN code. If you make a mistake, press the  key to move back to the incorrect number, then re-enter the correct number.
5. Make sure that the **BH-1** is off.
  6. Press and hold the power switch on the **BH-1 Bluetooth®** Headset for five seconds, until the **BH-1**'s indicator blinks red/blue alternately.
  7. Press the **PTT** key on the **FTM-10R** to initiate the pairing.
  8. If the pairing is successful (Requires a 20 to 30 seconds), “LINK OK” notation will appear on the display. The **FTM-10R** will turn off and back on again.

When the **BH-1 Bluetooth®** Headset is correctly recognized by the **FTM-10R**, the **BH-1**'s indicator will blink blue.

# Bluetooth® OPERATION

## To activate **Bluetooth®**:

1. Press and hold the [VOL/SEL] key for one second to activate the Menu Mode.
2. Rotate the **DIAL** knob to select Menu Item “F8 BLU VOX”.
3. Press the  key to enable selection of this Menu item.
4. Rotate the **DIAL** knob to select the desired **Bluetooth®** function:



OFF: Disable the **Bluetooth®** function.

PTT: Activate **Bluetooth®** function without the VOX feature.

VOX HIGH: Activate **Bluetooth®** function with the VOX feature (VOX gain: High).

VOX LOW: Activate **Bluetooth®** function with the VOX feature (VOX gain: Low).

5. Press the [VOL/SEL] key to save the new setting and exit to normal operation.

### *Effective Communications Range*

The communications range between the **BH-1** and the **FTM-10R** is around 10m (33 ft).

Obstacles between the **BH-1** and the **FTM-10R** may shorten the communications distance.

If you move out of range, the beeper sounds a low pitch tone. If you move back into range, the beeper sounds a high pitch tone.

## About the **Bluetooth®** Battery Indicator

When the **BH-1**'s battery voltage becomes low, the **BH-1**'s indicator will blink red/blue alternately, the beeper will sound a low pitch tone, and a “LOW BATT” icon will appear in the display. When the **BH-1** battery voltage becomes low, recharge the battery as soon as possible in the **CAB-1 Bluetooth®** Head Set Charger Sleeve.



**Note:** The **BH-1** is automatically turned off when it is inserted into the **CAB-1** charger.

If the **BH-1** is inserted correctly, the LED indicator will glow Red. A fully discharged battery will be charged completely in 3 hours. When charging is finished, the LED indicator will glow blue.

The **BH-1**'s approximate battery life is as follows:

Operating Band	Battery Life (Approx.)
AM/FM Broadcast, External Audio Input	3 hours
Amateur Band 1:1:8 (TX:RX:Standby)	Battery Saver ON: 10 hours Battery Saver OFF: 3 hours

## Battery Saver

If there has been no signal or key activity for 20 seconds, the Battery Save automatically puts the **BH-1** to “sleep”, to conserve battery life.

When a signal is received or the PTT key is pressed the **BH-1** will be active again.

You may enable the **BH-1** battery saver feature via Menu Item “F7 BLU SAVE” (See page 93).

# AF DUAL FUNCTION

---

The AF Dual function allows you to monitor your desired amateur band frequency while listening to an AM broadcast station.

You may monitor the FM broadcast station or external line input instead of an AM broadcast station by changing Menu Item “F2 AF DUAL” (The factory default is AM broadcast receiving).

1. Set the **FTM-10R** to the desired amateur band frequency while in VFO or Memory channel.
2. Press and hold the [VOL/SEL] key for one second to activate the Menu Mode.
3. Rotate the **DIAL** knob to select Menu Item “F2 AF DUAL”.
4. Press the  key to enable selection of this Menu item.
5. Rotate the **DIAL** knob to select the band and mode you want to listen to:



**AM AUTO:** You may monitor an amateur band frequency while listening to an AM Broadcast station. A signal received on the amateur frequency will be output to the speaker. When the amateur band signal drops, AF Dual function is resumed (The AM Broadcast audio is heard while the amateur band frequency is being monitored).



**AM HOLD:** You may monitor an amateur band frequency while listening to the AM Broadcast band. When a signal is received on the amateur band the audio will be output to the speaker. When the amateur band signal drops the **FTM-10R** remains in the amateur band continuously, and will not revert to AF Dual function.

**FM AUTO:** You may monitor an amateur band frequency while listening to an FM Broadcast station. A signal received on the amateur frequency will be output to the speaker. When the amateur band signal drops, AF Dual function is resumed (The AM Broadcast audio is heard while the amateur band frequency is being monitored).



**FM HOLD:** You may monitor an amateur band frequency while listening to the FM Broadcast band. When a signal is received on the amateur band, the audio will be output to the speaker. When the amateur band signal drops, the **FTM-10R** will remain in the amateur band continuously, and will not revert to AF Dual function.

**LI AUTO:** You may monitor an amateur band frequency while listening to the line audio. A signal received on the amateur frequency will be output to the speaker. When the amateur band signal drops, AF Dual function is resumed (The line audio is heard while the amateur band frequency is being monitored).





# AF DUAL FUNCTION

**LI HOLD:** You may monitor an amateur band frequency while listening to the line audio. When a signal is received on the amateur band, the audio will be output to the speaker. When the amateur band signal drops, the **FTM-10R** will remain in the amateur band continuously, and will not revert to AF Dual function.

6. Press and hold the  key for one second to activate the AF Dual function. The frequency selected by the VFO or memory in step one, will be heard with the AM or FM station from the speaker.
7. Rotate the **DIAL** knob to select the desired Broadcast station. You may switch the Broadcast Band frequency control between the VFO and Memory channel by pressing the  key.

When a signal is received in the amateur band, the amateur signal is heard instead of the Broadcast band or line audio. When the amateur band signal drops, the AF Dual function is resumed. (The amateur band frequency is monitored while receiving the Broadcast station or the line in audio)

You may transmit on the frequency, which is set on step1 by pressing the **PTT** key even if the AF Dual function is activated.

To disable the AF Dual function, press the front panel /  
 keys.



# CTCSS OPERATION

Many repeater systems require that a very-low-frequency audio tone be superimposed on your FM carrier in order to activate the repeater. This helps prevent false activation of the repeater by radar or spurious signals from other transmitters. This tone system, called “CTCSS” (Continuous Tone Coded Squelch System), is included in your **FTM-10R**, and is very easy to activate.

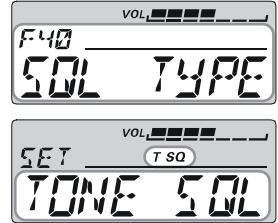

CTCSS setup involves setting the Tone Mode and then setting of the Tone Frequency. These actions are set up using Menu Items “F40 SQL TYPE” and “F39 SQL TSQF”.

1. Press and hold the [VOL/SEL] key for one second to activate the Menu Mode.
2. Rotate the **DIAL** knob to select Menu Item “F40 SQL TYPE”.
3. Press the  key to enable selection of this Menu Item.
4. Rotate the **DIAL** knob so that “TONE SQL” appears on the display. This means that the Tone Squelch system is active, which mutes your **FTM-10R**'s receiver until it receives a call from another radio sending out a matching CTCSS tone. This can help keep your radio quiet until a specific call is received, which may be helpful while operating in congested areas.



Note: 1) You may notice a “REV TONE” indication on the display while you rotate the **DIAL** knob in this step. This means that the Reverse Tone Squelch system is active, which mutes your **FTM-10R**'s receiver (instead of opening the squelch) when it receives a call from the radio sending a matched CTCSS tone. The “T SQ” icon will blink on the display when the Reverse Tone Squelch system is activated.

Note: 2) You may notice a “DCS” indication on the display while you rotate the **DIAL** knob still more. We'll discuss the Digital Code Squelch system shortly.

5. When you have made your selection of the CTCSS tone mode, press the  key momentarily, then rotate the **DIAL** knob three clicks counter-clockwise to select Menu Item “F39 SQL TSQF”. This Menu selection allows setting of the CTCSS tone frequency to be used.
6. Press the  key to enable adjustment of the CTCSS frequency.
7. Rotate the **DIAL** knob until the display indicates the Tone Frequency you need to use.
8. Press the [VOL/SEL] key to save the new setting and exit to normal operation.





**Note:** Your repeater may or may not re-transmit a CTCSS tone. Some systems just use CTCSS to control access to the repeater, but don't pass it along when transmitting. If the S-Meter deflects, but the **FTM-10R** is not passing audio, repeat steps “1” through “4” above, but rotate the **DIAL** knob so that “TONE” appears. This will allow you to hear all traffic on the channel being received.

CTCSS TONE FREQUENCY (Hz)									
67.0	79.7	94.8	110.9	131.8	156.7	171.3	186.2	203.5	229.1
69.3	82.5	97.4	114.8	136.5	159.8	173.8	189.9	206.5	233.6
71.9	85.4	100.0	118.8	141.3	162.2	177.3	192.8	210.7	241.8
74.4	88.5	103.5	123.0	146.2	165.5	179.9	196.6	218.1	250.3
77.0	91.5	107.2	127.3	151.4	167.9	183.5	199.5	225.7	254.1

# DCS OPERATION

Another form of tone access control is Digital Code Squelch, or DCS. It is a newer, more advanced tone system that generally provides more immunity from false paging than does CTCSS. The DCS Encoder/Decoder is built into your **FTM-10R**, and operation is very similar to that just described for CTCSS. Your repeater system may be configured for DCS. If not, it is frequently quite useful in Simplex operation if your friend(s) use transceivers equipped with this advanced feature.

**Note:** Just as in CTCSS operation, DCS requires that you set the Tone Mode to DCS and that you select a DCS Code.

1. Press and hold the [VOL/SEL] key for one second to activate the Menu mode.
2. Rotate the **DIAL** knob to select Menu Item “F40 SQL TYPE”.
3. Press the  key to enable selection of this Menu Item.
4. Rotate the **DIAL** knob so that “DCS” appears on the display. This means that the DCS Encoder/Decoder is active, which mutes your **FTM-10R**’s receiver until it receives a call from another radio sending out a matching DCS tone.
5. When you have made your selection of the DCS mode, press the  key momentarily, then rotate the **DIAL** knob two clicks counter-clockwise to select Menu Item “F36 SQL DCS”. This Menu selection allows setting of the DCS code to be used.
6. Press the  key to enable adjustment of the DCS code.
7. Rotate the **DIAL** knob until the display indicates the DCS code (three-digits number) you need to be using.
8. Press the [VOL/SEL] key to save the new setting and exit to normal operation.

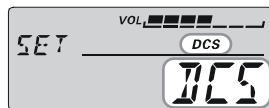

**Note:** Remember that DCS is an Encode/Decode system, so your receiver will remain muted until a matching DCS code is received on an incoming transmission. Switch the DCS off when you’re just tuning around the band!

DCS CODE														
023	047	073	131	156	223	251	271	332	371	445	465	532	631	723
025	051	074	132	162	225	252	274	343	411	446	466	546	632	731
026	053	114	134	165	226	255	306	346	412	452	503	565	654	732
031	054	115	143	172	243	261	311	351	413	454	506	606	662	734
032	065	116	145	174	244	263	315	356	423	455	516	612	664	743
036	071	122	152	205	245	265	325	364	431	462	523	624	703	754
043	072	125	155	212	246	266	331	365	432	464	526	627	712	-





# EPCS (ENHANCED PAGING & CODE SQUELCH) OPERATION

The **FTM-10R** includes an Enhanced CTCSS tone encoder/decoder and a dedicated micro-processor providing paging and selective calling features. This allows you to place a call to a specific station (Paging), and to receive calls of your choice directed only to you (Code Squelch).

The paging and code squelch systems use two pairs of (alternately switched) CTCSS tones, which are stored in the pager memories. Basically, your receiver remains silent until it receives the CTCSS tone pair that matches those stored in the Receiving Pager Memory. The squelch then opens so the caller is heard, and the paging ringer immediately sounds, if activated. When you close the **PTT** key to transmit, the CTCSS tone pair that is stored in the Transmitting Pager Memory will be transmitted automatically.

On the paged radio, the squelch will close automatically after the incoming page ends.

## STORING THE CTCSS TONE PAIRS FOR EPCS OPERATION

1. Press and hold the **[VOL/SEL]** key for one second to activate the Menu mode.
2. Rotate the **DIAL** knob to select Menu Item “F21 PAGER”.
3. Press the  key to enable selection of this Menu Item.
4. Press and hold the  key for one second to display the current Receiving CTCSS Tone Pair.
5. Rotate the **DIAL** knob to set the CTCSS Tone number that corresponds to the first tone of the Receiving CTCSS Tone Pair.
6. Press the  key, then rotate the **DIAL** knob to set the CTCSS Tone number that corresponds to the second tone of the Receiving CTCSS Tone Pair.
7. Repeat step 6 for setting the Transmitting CTCSS Tone Pair.
8. If you make a mistake, press the  key to move the cursor back one space, then re-select the correct number.
9. When you have made your selection of both Receiving and Transmitting CTCSS tone pairs, press the **[VOL/SEL]** key to save the new setting and exit to normal operation.



**Note:** The **FTM-10R** does not recognize the order of the 1st tone and the 2nd tone. In other words, for example, the **FTM-10R** considers both CTCSS pairs “10, 35” and “35, 10” to be identical.

# ***EPCS*** (ENHANCED PAGING & CODE SQUELCH) ***OPERATION***

---

## **ACTIVATING THE EPCS**

---

1. Press and hold the [VOL/SEL] key for one second to activate the Menu mode.
2. Rotate the **DIAL** knob to select Menu Item “F21 PAGER”.
3. Press the  key to enable selection of this Menu Item.
4. Rotate the **DIAL** knob to change the display to “ON”.
5. Press the [VOL/SEL] key momentarily to save the new setting and exit to normal operation.

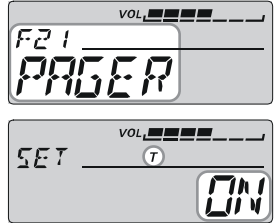



To disable the EPCS, just repeat the above procedure, rotating the **DIAL** knob to select “OFF” in step 4 above.

When the EPCS is activated, the “T” icon will blink during operation.

# INTERNET CONNECTION FEATURE (WiRES™)

The **FTM-10R** can be used to access a “node” (repeater or base station), which is tied into the Vertex Standard WiRES™ (Wide-Coverage Internet Repeater Enhancement System) network. Details may be found at the WiRES-II Web site: <http://www.vxstd.com/en/wiresinfo-en/>. This feature may also be used to access other systems, as described below.

## SRG (“SISTER RADIO GROUP”) MODE

1. Press and hold the [VOL/SEL] key for one second to activate the Menu mode.
2. Rotate the **DIAL** knob to select Menu Item “F48 WIRES”.
3. Press the  key to enable selection of this Menu Item.
4. Rotate the **DIAL** knob until “CODE” appears on the display. This activates WiRES™ in SRG mode. The “ key for one second. Then rotate the **DIAL** knob while to select the access number (“CODE 0” ~ “CODE 9”, “CODE A”, “CODE B”, “CODE C”, “CODE D”, “CODE E (\*)”, “CODE F (#)”) corresponding to the WiRES™ node to which you wish to establish the WiRES™ connection. (ask the node or repeater owner/operator if you don’t know the access number in the network).
6. Press the [VOL/SEL] key to save the new setting and exit to normal operation.
7. With the Internet Connection feature activated (as in step 4 above), the **FTM-10R** will generate a brief (0.1 second) DTMF tone according to your selection in step 5. This DTMF tone is sent at the beginning of every transmission to establish or maintain the link to the local WiRES™ node operating in the SRG mode.
8. To return to the FRG mode, repeat steps 1 - 4 above, selecting “MEM” in step 4, then press the [VOL/SEL] key to save the new setting and exit to normal operation.
9. To disable the Internet Connection feature, just repeat the above procedure, rotating the **DIAL** knob to select “OFF” in step 4 above, then press the [VOL/SEL] key to save the new setting and exit to normal operation (the “

**Note:** If other users report that you always have a DTMF “beep” at the beginning of each transmission, and you are not operating in conjunction with Internet access, disable this function via step (4) above.







# INTERNET CONNECTION FEATURE (WiRES™)

## FRG (“FRIENDLY RADIO GROUP”) MODE

You may access other Internet Link Systems (including WiRES™ in the “FRG” mode) that use a DTMF string for access.

### Programming the FRG code



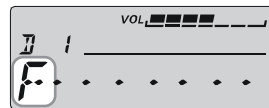

Load the DTMF tones that you wish to use for Internet-link access into a DTMF memory register. For purposes of this example, we will use “#(F)1101D” as the access code (the “#” key is denoted by the letter “F”).

1. Press and hold the [VOL/SEL] key for one second to activate the Menu mode.
2. Rotate the **DIAL** knob to select Menu Item “F13 DTMF”.
3. Press the  key to enable selection of this Menu Item.
4. Rotate the **DIAL** knob to select the DTMF memory register (D1 ~ D9) into which you wish to store the access code.
5. Press and hold the  key for one second. The first digit will blink.
6. Rotate the **DIAL** knob to select “F” (representing DTMF “#” the first digit of the DTMF string).  
“E” representing DTMF “\*” and “F” representing DTMF “#”
7. Press the  key momentarily to accept the first digit and move to the second digit of the DTMF string.
8. Repeat the previous steps until you have completed the access code (“# (F)1101D”).
9. If you make a mistake, press the  key to backspace the cursor, then re-enter the correct number.
10. Press and hold the  key for one second to save the new setting.
11. Repeat steps 1 through 10 to store other access codes, if so desired.
12. Press the [VOL/SEL] key to save the setting and exit to normal operation.



# INTERNET CONNECTION FEATURE (WiRES™)

## To accessing an FRG Node

1. Press and hold the [VOL/SEL] key for one second to activate the Menu mode.
2. Rotate the **DIAL** knob to select Menu Item “F48 WIRES”.
3. Press the  key to enable selection of this Menu Item.
4. Rotate the **DIAL** knob until “MEM” appears on the display.  
This activates WiRES™ in FRG mode. The “” icon will appear on the display.
5. Press and hold the  key for one second, then rotate the **DIAL** knob to select the Internet Memory register number (D1 ~ D9) corresponding to the Internet link repeater to which you wish to establish an Internet link.
6. Press the [VOL/SEL] key to save the new setting and exit to normal operation.
7. Once the Internet Connection feature is activated per step 4 above, you may now press the  key, while you are transmitting, to send out the selected DTMF string (to establish the link to the desired Internet-link node).
8. To disable the Internet Connection feature, repeat steps 1 - 4 above, selecting “OFF” in step 4, then press the [VOL/SEL] key to save the new setting and exit to normal operation (the “” icon will disappear from the display).

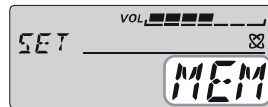







# DTMF AUTODIALER

Nine Autodialer memories are available on the **FTM-10R**. These DTMF Autodialer memories can store up to 16 digits of a telephone number for repeater autopatch or other use.

## To load the DTMF Autodialer memories:



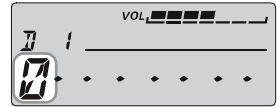
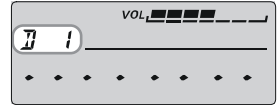

1. Press and hold the [VOL/SEL] key for one second to activate the Menu mode.
2. Rotate the **DIAL** knob to select Menu Item “F13 DTMF”.
3. Press the  key to enable selection of this Menu item.
4. Rotate the **DIAL** knob to select the DTMF AutoDial memory channel number into which you wish to store a telephone number (“D1” to “D9”). The previously stored telephone number is displayed on the LCD.
5. Press and hold the  key for one second.  
Press the **PTT** key to clear any previously stored telephone number, if desired.
6. Rotate the **DIAL** knob to select the first digit of the telephone number you wish to store. Then press the  key momentarily to save the first digit of the telephone number and move on to the next digit.  
“E” representing DTMF “\*” and “F” representing DTMF “#”
7. Repeat previous step for each digit in the telephone number. If you make a mistake, press the  key to move the cursor back to the previous digit, then re-enter the correct number.  
Press the **PTT** key to delete all data after the cursor that may have been previously stored erroneously.
8. When entries of all digits are complete, press and hold the  key for one second.
9. If you wish to store another DTMF string, repeat steps 4 through 8 above.
10. Press the [VOL/SEL] key momentarily to save the new setting and exit to normal operation.





# DTMF AUTODIALER

---

## To transmit the memorized telephone number:

1. Press the **PTT** key, then press and hold the  key while transmitting.  
The “DT MEM” indication will appear in the display for a moment (thus enabling the DTMF AutoDial), and “” icon will appear in the display.
2. Press the  key while maintaining a transmission.
3. Rotate the **DIAL** knob to select the DTMF AutoDial memory channel number you wish to transmit (“D1” to “D9”) while maintaining a transmission.
4. Press the  key again while maintaining a transmission.
  - The telephone number is transmitted.
  - If you use the optional DTMF hand Microphone “**MH-68A6J**”, you may send the telephone number using the following steps:
    1. First press the **PTT** key, then press the microphone’s numeric keys ([1] through [9]) corresponding to the DTMF memory string you wish to send.
    2. Once the string begins, you may release the **PTT** key, as the transmitter will be held “on the air” until the DTMF string is completed.
  - The transmitter will hold for 1.5 seconds after completion of the DTMF Memory string.

When the transmission is completed, press and hold the  key while transmitting to eliminate the “” icon.

# REPEATER OPERATION

The **FTM-10R** includes a host of convenient features that makes operation on amateur repeaters both efficient and enjoyable.

The **FTM-10R** offers three methods of setting up split-frequency operation on repeaters:

Manual selection of preset repeater shifts (Standard Repeater Shift);

Automatic Repeater Shift (ARS), providing automatic activation of repeater shifts while operating within designated repeater frequency subbands.

Independently stored transmit and receive frequencies (typically not corresponding to established repeater frequency shifts).

## Standard Repeater Shift

To activate the standard shift manually, you may use the Menu mode:

1. Press and hold the [VOL/SEL] key for one second to activate the Menu mode.
2. Rotate the **DIAL** knob to select Menu Item “F25 RPT MODE”.
3. Press the  key to enable selection of this Menu Item.
4. Rotate the **DIAL** knob to select desired shift direction (RPTR-, RPTR+, or RPTR OFF).
5. Press the [VOL/SEL] key momentarily to save the new setting and exit to normal operation.



Your **FTM-10R** has been configured, at the factory, for the repeater offset customary in your country. For the 144 MHz band offset will be 600 kHz; on the 430 MHz band, the offset may be 1.6 MHz, 7.6 MHz, or 5 MHz (USA version). You can change the offset using the following procedure, if needed for vacation travel or other purposes:

1. Press and hold the [VOL/SEL] key for one second to activate the Menu mode.
2. Rotate the **DIAL** knob to select Menu Item “F26 RPT SFT”.
3. Press the  key to enable selection of this Menu Item.
4. Rotate the **DIAL** knob to set the desired offset. Note that the resolution of the “Standard” repeater shift is to the nearest 50 kHz multiple.
5. Press the [VOL/SEL] key to save the new setting and exit to normal operation.



**Note:** Do not use this procedure for programming of an “odd split” type repeater pair! The process for programming odd splits is shown on page 42.

# REPEATER OPERATION/BAND EXPANSION

## Automatic Repeater Shift

The ARS (Automatic Repeater Shift) feature in this transceiver allows easy and convenient repeater operation by automatically activating the repeater shift function whenever you tune to a frequency in a standard repeater sub band. The ARS function is preset at the factory to conform to the standards for the country to which it is exported.

The ARS function is enabled at the factory. To disable ARS:

1. Press and hold the **[VOL/SEL]** key for one second to activate the Menu mode.
2. Rotate the **DIAL** knob to select Menu Item “F24 RPT ARS”.
3. Press the **[▶]** key to enable selection of this Menu Item.
4. Rotate the **DIAL** knob to change the display to “OFF”.
5. Press the **[VOL/SEL]** key to save the new setting and exit to normal operation.



To enable the ARS function again, just repeat the above procedure, rotating the **DIAL** knob to select “ON” in step 4 above.

## BAND EXPANSION

The **FTM-10R** can receive the following frequency bands via the Menu Item.

AIR: 108 - 137 MHz and 300 - 336 MHz

GR1: 174 - 222 MHz and 470 - 800 MHz

GR2: 336 - 420 MHz and 800 - 999.9875 MHz (cellular blocked)





1. Press and hold the **[VOL/SEL]** key for one second to activate the Menu mode.
2. Rotate the **DIAL** knob to select Menu Item “F27 RX EXP”.
3. Press the **[▶]** key to enable selection of this Menu Item.
4. Rotate the **DIAL** knob to change the setting to “EXPAND”.
5. Press the **[VOL/SEL]** key to save your new setting and resume normal operation.



When the band is expanded, you can see the “AIR”, “GR1”, and “GR2” additional frequency bands between the “WX Band” and “Audio Line”.

# ***WEATHER BROADCAST CHANNEL OPERATION***

The VHF Weather Broadcast Station Memory Channel Bank has been pre-programmed at the factory, for quick selection of NOAA weather information stations.

1. Press the front panel / key to recall the Weather Broadcast Station Memory Bank (“WX” notation will appear at the upper left corner in the display for a moment).
2. Rotate the **DIAL** knob to select the desired Weather Broadcast channel.
3. If you wish to scan this bank to search for louder stations, just press the **PTT** key. When the scanner pauses on a station, press the **PTT** key once to halt the scan, or press it twice to restart the scan.
4. To exit from the Weather Broadcast Station Memory mode, press the front panel / keys to select the desired operating band.

CH	FREQUENCY	CH	FREQUENCY
1	162.550 MHz	6	162.500 MHz
2	162.400 MHz	7	162.525 MHz
3	162.475 MHz	8	161.650 MHz
4	162.425 MHz	9	161.775 MHz
5	162.450 MHz	10	163.275 MHz

## **Severe Weather Alert**

In the event of extreme weather disturbances, such as storms and hurricanes, the NOAA (National Oceanic and Atmospheric Administration) sends a weather alert accompanied by a 1050 Hz tone and subsequent weather report on one of the NOAA weather channels.

# MISCELLANEOUS SETTING

---

---

## CHANNEL STEP SELECTION

---

---

Tuning steps are factory preset to default increments which are appropriate for the country to which this radio is exported. You may have a reason to use a different step size, however, and here is the procedure for changing the channel steps:

1. Press and hold the **[VOL/SEL]** key for one second to activate the Menu mode.
2. Rotate the **DIAL** knob to select Menu Item “F41 STEP”.
3. Press the **[▶]** key to enable selection of this Menu Item.
4. Rotate the **DIAL** knob to select the desired step size:  
5.00, 6.25, 8.33, 10.00, 12.50, 15.00, 20.00, 25.00, 50.00, 100.00, 200.00 kHz or AUTO.
5. Press the **[VOL/SEL]** key to save the new setting and exit to normal operation.  
Note: 1) AM BC band only selects 9 kHz or 10 kHz.  
Note: 2) FM BC band only selects 50 kHz, 100 kHz, or 200 kHz.  
Note: 3) Steps of 5 kHz, 6.25 kHz, 8.33kHz, and 9 kHz are not available above 470 MHz.

---

## CHANGING THE OPERATING MODE

---

---

The **FTM-10R** provides for automatic mode changing when the radio is tuned to different operating frequencies. However, should an unusual operating situation arise in which you need to change between the available operating modes (FM, FM-Narrow, FM-Wide, and AM), here is the procedure for doing so:

1. Press and hold the **[VOL/SEL]** key for one second to activate the Menu mode.
2. Rotate the **DIAL** knob to select Menu Item “F29 RX M MOD”.
3. Press the **[▶]** key to enable selection of the operating mode. The current operating mode appears on the LCD.
4. Rotate the **DIAL** knob to select the desired operating mode.  
AUTO: Automatic mode setting per default values for the selected frequency range.  
WIDE FM: Frequency Modulation for receiving an FM Broadcast Station.  
FM: Frequency Modulation for receiving an Amateur Radio Station and most VHF/UHF Communication.  
NARR FM: Frequency Modulation for receiving some Amateur Radio Stations and VHF/UHF Communication.  
AM: Amplitude Modulation for receiving a AM Radio Station and Air Band Communication.

Press the **[VOL/SEL]** key to save the new setting and resume normal operation.

# MISCELLANEOUS SETTING

---

## PTT KEY FUNCTION

---

You can change the operation of the **PTT** key if desired.

1. Press and hold the [**VOL/SEL**] key for one second to activate the Menu mode.
2. Rotate the **DIAL** knob to select Menu Item “F23 PTT MODE”.
3. Press the  key to enable selection of the **PTT** key function. The current **PTT** key function appears on the LCD.
4. Rotate the **DIAL** knob to select the desired **PTT** key function.

**MOMENT:** Press and hold the **PTT** key, to activate the transmitter. Release the **PTT** key, to return to receive.

**TOGGLE:** Briefly press the **PTT** key to activate the transmitter. Briefly, press the **PTT** key once again, to return to receive.

5. Press the [**VOL/SEL**] key to save the new setting and resume normal operation.

---

## KEY BEEPER

---

A key beeper provides useful audible feedback whenever a key is pressed.

Follow this procedure to turn the beeper on or off:

1. Press and hold the [**VOL/SEL**] key for one second to activate the Menu mode.
2. Rotate the **DIAL** knob to select Menu Item “F6 BEEP”.
3. Press the  key to enable selection of this Menu Item.
4. Rotate the **DIAL** knob to change the setting to “OFF”.
5. Press the [**VOL/SEL**] key to save the new setting and exit to normal operation.
6. To turn the beep back on again, select “KEY” or “KEY+SC (factory default)” in step 4 above.

**KEY:** The beeper sounds when you press the key.



**KEY+SC:** The beeper sounds when you press the key, or when the scanner stops.

---

## SMART KEY SELECT

---

You may assign/exclude the functions which recall with the top panels' / key.

1. Press and hold the [**VOL/SEL**] key for one second to activate the Menu mode.
2. Rotate the **DIAL** knob to select Menu Item “F15 FKEY SEL”.
3. Press the  key to enable selection of this Menu Item.
4. Rotate the **DIAL** knob to select the function you wish to assign or exclude.
5. Press and hold the  key for one second to toggle the function on (assign) and off (exclude).
6. Press the [**VOL/SEL**] key to save the new setting and exit to normal operation.

# MISCELLANEOUS SETTING

---

---

## REPEATER SHIFT DIRECTION

---

You may select the Repeater Shift Direction.

1. Press and hold the **[VOL/SEL]** key for one second to activate the Menu mode.
2. Rotate the **DIAL** knob to select Menu Item “F25 RPT MODE”.
3. Press the **[▶]** key to enable selection of this Menu Item.
4. Rotate the **DIAL** knob to select desired shift direction (RPTR-, RPTR+, or RPTR OFF).
5. Press the **[VOL/SEL]** key momentarily to save the new setting and exit to normal operation.

The repeater offset is fixed to 600 kHz on the 144 MHz band and 5 MHz on the 430 MHz band from the factory. You can change the offset via the Menu mode “F26 RPT SFT”.

---

## REPEATER SHIFT OFFSET

---

1. Press and hold the **[VOL/SEL]** key for one second to activate the Menu mode.
2. Rotate the **DIAL** knob to select Menu Item “F26 RPT SFT”.
3. Press the **[▶]** key to enable selection of this Menu Item.
4. Rotate the **DIAL** knob to select desired offset.
5. Available selections are 0.00 - 99.95 MHz (50 kHz increments).
6. Press the **[VOL/SEL]** key momentarily to save the new setting and exit to normal operation.

---

## AUTOMATIC REPEATER SHIFT

---

The ARS (Automatic Repeater Shift) feature in this transceiver allows easy and convenient repeater operation by automatically activating the repeater shift function whenever you tune to a frequency in a standard repeater sub band. The ARS function is preset at the factory to conform to the standards for the country to which it is exported.

The ARS function is enabled at the factory. To disable ARS:

1. Press and hold the **[VOL/SEL]** key for one second to activate the Menu mode.
2. Rotate the **DIAL** knob to select Menu Item “F24 RPT ARS”.
3. Press the **[▶]** key to enable selection of this Menu Item.
4. Rotate the **DIAL** knob to change the display to “OFF”.
5. Press the **[VOL/SEL]** key to save the new setting and exit to normal operation.

To enable the ARS function again, just repeat the above procedure, rotating the **DIAL** knob to select “ON” in step 4 above.



# MISCELLANEOUS SETTING

---

## PROGRAMMING THE KEY ASSIGNMENTS

---

In the factory default, the optional **MH-68A6J/MH-68B6J** Microphone's [PGM] key functions have been assigned to the "WX CH". This may be changed by the user if you wish to assign quick access to another function.

To change the assignments for the **MH-68A6J/MH-68B6J** Microphone's [PGM] key:

1. Press and hold the [VOL/SEL] key for one second to activate the Menu mode.
2. Rotate the **DIAL** knob to select Menu Item "F20 MIC PRGM".
3. Press the  key to enable selection of this Menu item.
4. Rotate the **DIAL** knob to select the function you wish to assign to the [PGM] key. The available choices are:

MONI: Disable the noise and tone squelch systems.

T CALL: Activates 1750 Hz Tone Burst

SSCH: Engages the Smart Search operation.

ARTS: Engages the ARTS™ operation.

TAG: Switches the display between indication of the frequency or the channel's Alpha/Numeric label while receiving on the memory channel.

MHz: Allows 1-MHz tuning steps while receiving in VFO mode.

SCAN: Engages the Scan operation.

CLUB: Recall the CLUB channel.

WX: Switches operation to the Weather Channel bank.

SQLLVL: Selects the Squelch Threshold Level

TX LOW: Selects the Transmitter Power Level.

RPTR: Sets the Repeater Shift Direction.

SQL TYP: Selects the CTCSS/DSC Operation.

REV: Reverses the Transmit and receive frequency during split-frequency operation.

TSQLF: Selects the CTCSS frequency.

DCODE: Selects the DCS code.

5. Press the [VOL/SEL] key to save the new setting and exit to normal operation.

# MISCELLANEOUS SETTING

---

---

## SCANNING BAND

---

By default, the **FTM-10R** considers the 144 MHz Amateur Band and 430 MHz Amateur Band to be independent bands while the scanner is activated. You may change scanner operation so that both the 144 MHz Amateur Band and the 430 MHz Amateur Band are scanned as one band.

1. Press and hold the **[VOL/SEL]** key for one second to activate the Menu mode.
2. Rotate the **DIAL** knob to select Menu Item “F30 SCN CVRG”.
3. Press the **[▶]** key to enable selection of this Menu Item.
4. Rotate the **DIAL** knob to select the desire mode.

**IN BAND:** The **FTM-10R** considers the 144 MHz Amateur Band and 430 MHz Amateur Band to be an independent band and scans these when the scan mode is engaged. Activate the scanner on the 144 MHz Amateur Band only (or 430 MHz Amateur Band only).

**HAM BAND:** The **FTM-10R** considers the 144 MHz Amateur Band and 430 MHz Amateur Band to be one band and scans it when the scan mode is engaged. Activate the scanner across the 144 MHz Amateur Band and 430 MHz Amateur Band.

5. Press the **[VOL/SEL]** key to save the new setting and exit to normal operation.

---

## SCAN-RESUME MODE

---

Three scan-resume modes are available on the **FTM-10R**:

**BUSY:** In this mode, the scanner will remain halted for as long as there is carrier present on the channel. After the carrier drops at the end of the other station's transmission, scanning will resume.

**HOLD:** In this mode, the scanner will halt on a signal it encounters. It will not restart automatically; you must manually re-initiate scanning if you wish to resume.

**TIME 3S/5S/10S:** In these modes, the scanner will halt for the selected resume time, after which scanning will resume (whether or not the other station is still transmitting).

The default scan-stop mode is “BUSY”. To change the scan-resume mode, use the following procedure:

1. Press and hold the **[VOL/SEL]** key for one second to activate the Menu mode.
2. Rotate the **DIAL** knob to select Menu Item “F32 SCN MODE”.
3. Press the **[▶]** key to enable selection of this Menu Item.
4. Rotate the **DIAL** knob to set the desired scan-resume mode.
5. Press the **[VOL/SEL]** key to save the new setting and exit to normal operation.

# MISCELLANEOUS SETTING

---

## SCAN DIRECTION

---

By default, the VFO frequency will jump to the low band edge of the current band when the VFO frequency reaches the high band edge. You may change the scanner operation so that the VFO frequency will change to downward scanning when the VFO frequency reaches the high band edge.

1. Press and hold the [VOL/SEL] key for one second to activate the Menu mode.
2. Rotate the **DIAL** knob to select Menu Item “F31 SCN DRCT”.
3. Press the  key to enable selection of this Menu Item.
4. Rotate the **DIAL** knob to set the desired scan mode.

**NORMAL:** When the VFO frequency reaches the high band edge of the current band, the VFO frequency will jump to the low band edge of the current band (or vice versa).

**RETURN:** When the VFO frequency reaches the high band edge of the current band while scanning upward, the scanner will reverse direction and scan downwards. (or vice versa).

5. Press the [VOL/SEL] key to save the new setting and exit to normal operation.

---

## SCAN START DIRECTION

---

By default, the scanner initiates scanning upward when activates the scanner by pressing the top panels'  key. You may change the scan start direction to downward scanning.

1. Press and hold the [VOL/SEL] key for one second to activate the Menu mode.
2. Rotate the **DIAL** knob to select Menu Item “F33 SCN STRT”.
3. Press the  key to enable selection of this Menu Item.
4. Rotate the **DIAL** knob to set the desired direction.

**UP START:** the scanner initiates scanning upward.

**DWN.TRART:** the scanner initiates scanning downward.

Press the [VOL/SEL] key to save the new setting and exit to normal operation.

# MISCELLANEOUS SETTING

---

---

## SPLIT TONE OPERATION

---

The **FTM-10R** can be operated in a “Split Tone” configuration, to enable operation on repeaters using a mix of both CTCSS and DCS control.

1. Press and hold the **[VOL/SEL]** key for one second to activate the Menu mode.
2. Rotate the **DIAL** knob to select Menu Item “F37 SQLEXP”.
3. Press the **[▶]** key to enable selection of this Menu item.
4. Rotate the **DIAL** knob to set this Menu item to “ON” (to enable the Split Tone feature)
5. Press the **[VOL/SEL]** key momentarily to save the new setting and exit to normal operation.

When the Split Tone feature is activated, you can see the following additional parameters following the “DCS” parameter (while selecting the tone mode via Menu item “F40 SQL TYPE”):

DCS ENC: DCS Encode only (the “**DCS**” icon will blink during operation).

TONE DCS: Encodes a CTCSS Tone and Decodes a DCS code (the “**T**” icon will blink and the “**DCS**” icon will appear during operation).

DCS TSQL: Encodes a DCS code and Decodes a CTCSS Tone (the “**TSQ**” icon will appear and the “**DCS**” icon will blink during operation)

---

## CTCSS/DCS/EPCS BELL OPERATION

---

During CTCSS Decode, DCS, or EPCS operation, you may set up the **FTM-10R** so that a ringing “bell” sound alerts you when a call is coming in.

1. Press and hold the **[VOL/SEL]** key for one second to activate the Menu mode.
2. Rotate the **DIAL** knob to select Menu Item “F35 SQL BELL”.
3. Press the **[▶]** key to enable selection of this Menu Item.
4. Rotate the **DIAL** knob to set the desired number of rings of the Bell. The available choices are 1, 3, 5, or 8 rings, CONT (continuous ringing), or OFF.
5. Press the **[VOL/SEL]** key momentarily to save the new setting and exit to normal operation.

When you are called by a station whose transceiver is sending a CTCSS tone, DCS code, or CTCSS code pair which matches that set into your Decoder, the Bell will ring in accordance with this programming.

# MISCELLANEOUS SETTING

---

## BATTERY VOLTAGE DISPLAY

---

You can display the vehicle's battery voltage on the display at any time.

1. Press and hold the [VOL/SEL] key for one second to activate the Menu mode.
2. Rotate the **DIAL** knob to select Menu Item "F11 DC VOLT".
3. Press the  key to display the vehicle's battery voltage on the display.
4. Press the [VOL/SEL] key to exit Battery Voltage mode and return to normal operation.

## TEMPERATURE DISPLAY

---

You can show the temperature inside the front panel on the display.

1. Press the [VOL/SEL] key repeatedly to display the Clock, Stop Watch Timer, or Thermometer.  
The display returns to the frequency display automatically if you leave an interval of three seconds without entering the next operation. Please enter the next step within the 3 second interval.
2. Rotate the **DIAL** knob to display the temperature (TMP XX °C)  
The display automatically returns to the frequency display in approximately three seconds.  
You may change the status that the **DIAL** knob does not return automatically to the Frequency. See the explanation of the Menu Item "F5 AF-VFO".

## CLOCK FORMAT

---

You may select the Clock Format via the Menu mode. Available selections are "HH:MM:SS", "HH:MM", and "MM:SS".

1. Press the [VOL/SEL] key repeatedly to display the Clock, Stop Watch Timer, or Thermometer.  
The display returns to the frequency display automatically if you leave an interval of approximately three seconds before the next operation. Please operate the next step within the 3 second interval.
2. Press and hold the [VOL/SEL] key for one second.
3. Rotate the **DIAL** knob to select the Menu Item "T3 T FORMAT".
4. Press the  key momentarily. Then rotate the **DIAL** knob to select the desired Clock Format.
5. Press the [VOL/SEL] key to save the new setting and exit to normal operation.

# MISCELLANEOUS SETTING

---

---

## TIME SYSTEM

---

You may select the Time System between “12H” and “24H” via the Menu mode.

1. Press the **[VOL/SEL]** key repeatedly to display the Clock, Stop Watch Timer, or Thermometer.  
The display returns to the frequency display automatically if you leave an interval of approximately three seconds before the next operation. Please operate the next step within the 3 second interval.
2. Press and hold the **[VOL/SEL]** key for one second.
3. Rotate the **DIAL** knob to select the Menu Item “T4 12H/24H”.
4. Press the **[▶]** key momentarily. Then rotate the **DIAL** knob to select the desired Time System.
5. Press the **[VOL/SEL]** key to save the new setting and exit to normal operation.

## ALARM SET

---

You may set an alarm beep which will sound every “00” minutes via the Menu mode.

1. Press the **[VOL/SEL]** key repeatedly to display the Clock, Stop Watch Timer, or Thermometer.
2. Press and hold the **[VOL/SEL]** key for one second.
3. Rotate the **DIAL** knob to select the Menu Item “T2 CLOCK BP”.
4. Press the **[▶]** key momentarily. Then rotate the **DIAL** knob to change the setting to “ON”.
5. Press the **[VOL/SEL]** key to save the new setting and exit to normal operation.

To turn the alarm off again, select “OFF” in step 4 above.

## INTERVAL BEEP

---

The **FTM-10R**'s Stop Watch Timer allows programming a timed interval when a beep will sound and the white LED will flash.

1. Press the **[VOL/SEL]** key repeatedly to recall the Clock/Timer mode.
2. Press and hold the **[VOL/SEL]** key for one second to activate the Clock/Timer Customization mode.
3. Rotate the **DIAL** knob to select Menu Item “T5 TMR BEEP”.
4. Press the **[▶]** key momentarily to enable selection of this Menu Item.
5. Rotate the **DIAL** knob to select the desired interval. Available selections are “5MIN” through “60MIN” (5MIN increment) or “OFF”.
6. Now, press the **[VOL/SEL]** key to save the new setting and exit to Clock/Timer mode.

To disable the interval timer, just repeat the above procedure, rotating the **DIAL** knob to select “OFF” in step 5 above.

# MISCELLANEOUS SETTING

---

## AUTOMATIC POWER-OFF (APO)

---

The “Automatic Power-Off” (APO) feature will turn the radio completely off after a user-defined period of **PTT** or key/button inactivity. If you do not press any front panel keys or buttons, rotate the **DIAL** knob, use the microphone’s keys and buttons, or transmit, and so long as the transceiver is not scanning or engaged in priority monitoring, the radio will shut itself off after the specified time period.

The **FTM-10R** can operate the Automatic Power-Off feature through the Clock/Timer function.

The available selections for the time before power-off are 0.5 - 12.0 hours (0.5 hour increments), as well as APO Off. This feature is useful in minimizing battery drain in a mobile installation if you forget to turn the transceiver off when you leave your vehicle.

To activate the APO feature:

1. Press the [**VOL/SEL**] key repeatedly to display the Clock, Stop Watch Timer, or Thermometer.
2. Press and hold the [**VOL/SEL**] key for one second.
3. Rotate the **DIAL** knob to select Menu Item “T6 APO”.
4. Press the  key to enable selection of this Menu Item.
5. Rotate the **DIAL** knob to select desired time, after which the radio will automatically shut down. Available selections are 0.5 to 12.0 hours (0.5 hour increments), or Off.
6. Press the [**VOL/SEL**] key to save the new setting and exit to Clock/Timer mode.

If there is no action by you within the time interval programmed, a ringer sounds 3 minutes before the APO shutdown time. Three minutes thereafter, the microprocessor will shut down the radio automatically.

---

## AUDIO PITCH CONTROL

---

The **FTM-10R** includes a feature that lets you choose six special receiver audio responses to allow the most comfortable and effective reception in noisy environments. The effect is similar to that provided by a “Tone Control” in a stereo.

1. Press and hold the [**VOL/SEL**] key for one second to activate the Menu mode.
2. Rotate the **DIAL** knob to select Menu Item “F3 AF PITCH”.
3. Press the  key to enable selection of this Menu Item.
4. Rotate the **DIAL** knob to select the desired receiver audio response. Available selections are LOW-3, LOW-2, LOW-1, NORMAL, HIGH-1, and HIGH-2.
5. Press the [**VOL/SEL**] key to save the new setting and exit to normal operation.

# MISCELLANEOUS SETTING

---

---

## VOLUME SETTING ALERT FEATURE

---

---

The **FTM-10R** provides the Volume Setting Alert feature.

1. Press and hold the **[VOL/SEL]** key for one second to activate the Menu mode.
2. Rotate the **DIAL** knob to select Menu Item “F4 AF PREST”.
3. Press the **[▶]** key to enable selection of this Menu item.
4. Rotate the **DIAL** knob to select the desired effect level.

**OV ALERT:** Activates the Volume Setting Alert feature. A lamp at the left of the **DIAL** knob blinks orange when volume level is set to the  $\pm 3$  steps of the preset level.

**LV ALERT:** Activates the Volume Setting Alert feature. A lamp at the left of the **DIAL** knob blinks orange when volume level is set to the preset level minus 3 steps.

**HV ALERT:** Activates the Volume Setting Alert feature. A lamp at the left of the **DIAL** knob blinks orange when volume level is set to the preset level plus 3 steps above.

**OFF:** Disable the Volume Setting Alert feature.

5. Press and hold the **[▶]** key for one second, then rotate the **DIAL** knob to select the desired preset level.
6. Press the **[VOL/SEL]** key to save the new setting and exit to normal operation.

---

---

## SPEAKER SELECTION

---

---

You may choose the speaker to be used.

1. Press and hold the **[VOL/SEL]** key for one second to activate the Menu mode.
2. Rotate the **DIAL** knob to select Menu Item “F34 SPEAKER”.
3. Press the **[▶]** key to enable selection of this Menu item.
4. Rotate the **DIAL** knob to select the desired the speaker to be used.

**REAR:** Outputs the receiving audio from the REAR speaker (located in the transceiver’s body).

**F+R:** Outputs the receiving audio from both FRONT (located in the front panel) and REAR speakers.

**FRONT:** Outputs the receiving audio from the FRONT (located in the front panel) speaker.

**OFF:** Disable the FRONT and REAR Speakers.

5. Press the **[VOL/SEL]** key to save the new setting and exit to normal operation.

If you use the external speaker, this Menu Item is set to “REAR” or “F+R”.



# MISCELLANEOUS SETTING

---

---

## STEREO/MONAUROUS SELECTION

---

You may enjoy the FM Broadcast and external audio input in stereo output.

1. Press and hold the [VOL/SEL] key for one second to activate the Menu mode.
2. Rotate the **DIAL** knob to select Menu Item “F42 STEREO”.
3. Press the  key to enable selection of this Menu item.
4. Rotate the **DIAL** knob to select between “STEREO” and “MONO”.
5. Press the [VOL/SEL] key to save the new setting and exit to normal operation.

When Stereo Audio Output is selected, an “” icon appears on the display.

---

## MIC GAIN SETTING

---

At the factory, a microphone gain has been programmed that should be satisfactory for the internal microphone and optional **MH-68A6J/ MH-68B6J**. If you use an after-market microphone, you may wish to set a different Microphone Gain Level.

1. Press and hold the [VOL/SEL] key for one second to activate the Menu mode.
2. Rotate the **DIAL** knob to select Menu Item “F19 MIC GAIN”.
3. Press the  key to enable selection of this Menu Item.
4. Rotate the **DIAL** knob to select the desired Microphone Gain Level. Available selections are MIN, LOW, NORMAL, HIGH, and MAX.
5. Press the [VOL/SEL] key to save the new setting and exit to normal operation.

---

## PTT Lock

---

You may also lock out the **PTT** key when the LOCK mode is activated.

1. Press and hold the [VOL/SEL] key for one second to activate the Menu mode.
2. Rotate the **DIAL** knob to select Menu Item “F22 PTT LOCK”.
3. Press the  key to enable selection of this Menu Item.
4. Rotate the **DIAL** knob to select “ON” (Lock) or “OFF” (unlock).

Press the [VOL/SEL] key to save the new setting and exit to normal operation.

# MENU (“SET”) MODE

The **FTM-10R** Menu Mode, already described in parts of many previous chapters, is easy to activate and set. It may be used for configuration of a wide variety of transceiver parameters, some of which have not been detailed previously. Use the following procedure to activate the Menu mode:

1. Press and hold the [VOL/SEL] key for one second to enter the Menu mode.
2. Rotate the **DIAL** knob to select the Menu Item to be adjusted.
3. Press the  key momentarily to enable adjustment of the Menu Item.
4. Rotate the **DIAL** knob to adjust or select the parameter to be changed on the Menu Item selected in the above step.
5. After completing your selection and adjustment, press the [VOL/SEL] key to save the new setting and exit to normal operation.

Item #	Menu Item	Function	Available Values (Default: <i>Bold Italic</i> )
1	AF AUTO	Enables/Disables the Automatic Audio Volume Controller.	<b>OFF/ON</b> MIN/ON MID/ON MAX
2	AF DUAL	Enables/Disables the AF DUAL operation.	<b>OFF/</b> AM AUTO / AM HOLD/ FM AUTO/ FM HOLD/ LI AUTO / LI HOLD
3	AF PITCH	Select the Tone Pitch control for the received audio.	LOW-3/LOW-2/LOW-1/ <b>NORMAL</b> /HIGH-1/HIGH-2
4	AF PREST	Enable/Disable the Volume Setting Alert feature.	<b>OFF/OV</b> ALERT/LV ALERT/ HV ALERT
5	AF-VFO	Select the DIAL knob and display function.	TOGGLE/ <b>AUTOBACK</b>
6	BEEP	Enables/Disables the beeper.	<b>KEY+SC</b> /KEY/OFF
7	BLU SAVE	Enable/Disable the battery saver of the optional BH-1 <i>Bluetooth</i> <sup>®</sup> Headset.	<b>OFF/ON</b>
8	BLU VOX	Enables/Disables the <i>Bluetooth</i> <sup>®</sup> function (requires the optional BU-1 <i>Bluetooth</i> <sup>®</sup> Unit).	OFF/ <b>PTT</b> /VOX HIGH/VOXLOW
9	CLOCK	Activates/Disables the Internal Clock/Stop Watch Timer.	<b>OFF/ON</b>
10	CLUB PRI	Activates the Club Channel Monitor.	<b>OFF/AUTO/HOLD</b>
11	DC VOLT	Indicates the DC Supply Voltage.	—
12	DIMMER	Setting of the display's illumination level.	DIMMER 1 ~ <b>DIMMER 5</b>
13	DTMF	Programming of the DTMF Autodialer.	—
14	FKEY MOD	Selects the category which is recalled from the top panel  key.	<b>FNC</b> FNC+MSG/MSG
15	FKEY SEL	Assigns a function to the Function Key.	AF DUAL, ARTS, DIMMER, HORN 1, HORN 2, HORN 3, HORN 4, INTERCOM, MONI, <b>PA</b> , REVERSE, SCAN, SQL LEVEL, SSCH, TCALL, TX POWER, VOL.ITCOM
16	ID LIST	Programming a Member List for the Message feature.	—
17	ID REG	Sets your Personal ID for the Message feature.	—
18	MESSAGE	Programming a Message for the Message feature.	—
19	MIC GAIN	Adjust the microphone gain level.	MIN/LOW/ <b>NORMAL</b> /HIGH/ MAX
20	MIC PRGM	Select the function of the microphone's [PGM] key.	TX LOW/RPTR/SQLTYP/REV/ TSQF/DCODE/MONI/TCALL/ SSCH/ARTS/TAG/MHz/SCAN/ CLUB/ <b>WX</b>
21	PAGER	Enables/Disables the Enhanced CTCSS Paging & Code Squelch function and setting the Receiving/Transmitting Pager Code for the Enhanced CTCSS Paging & Code Squelch function.	<b>OFF/ON</b>
22	PTT LOCK	Enables/Disables the locking of the PTT key when the LOCK mode is activated.	<b>OFF/ON</b>
23	PTT MODE	Selects the PTT key function.	<b>MOMENT</b> /TOGGLE
24	RPT ARS	Enables/Disables the Automatic Repeater Shift function.	<b>ON/OFF</b>
25	RPT MODE	Sets the Repeater Shift Direction.	RPTR OFF/RPTR-/RPTR+ (x)

# MENU (“SET”) MODE

Item #	Menu Item	Function	Available Values (Default: <b><i>Bold Italic</i></b> )
26	RPT SFT	Sets the magnitude of the repeater Shift.	0.00 ~ 99.95 MHz (*) (50 kHz increments)
27	RX EXP	Enables/Disables the band expansion.	<b>NORMAL/EXPAND</b>
28	RX F CCL	Shifting of the CPU clock frequency.	<b>OFF/ON</b>
29	RX M MOD	Selects the receiving mode.	<b>AUTO/WIDE FM/FMNARR FM/AM</b>
30	SCN CVRG	Selects the Scan range.	<b>IN BAND/HAM BAND</b>
31	SCN DRCT	Select the Scan type.	<b>NORMAL/RETURN</b>
32	SCN MODE	Selects the Scan Resume mode.	<b>BUSY/HOLD/TIME 3S/TIME 5S/TIME 10S</b>
33	SCN STRT	Select the scan start direction which initiates the scanner using the scan command by pressing the  key.	<b>UP START/DN.START</b>
34	SPEAKER	Select the Speaker to be used.	<b>REAR/F+R/FRONT/OFF</b>
35	SQL BELL	Selects the number of CTCSS/DCS/EPCS Bell ringer repetitions.	<b>OFF/1T/3T/5T/8T/CONT</b>
36	SQL DCS	Setting of the DCS code.	104 standard DCS codes ( <b>023</b> )
37	SQL EXP	Enables/Disables split CTCSS/DCS coding.	<b>OFF/ON</b>
38	SQL LEVL	Set the squelch threshold level.	SQL OFF/SQL MIN/SQL 01 ~ SQL 06/ SQL MAX <b>Amateur Bands: SQL 01 AM: SQL 01, FM: SQL 02</b>
39	SQL TSQF	Setting of the CTCSS Tone Frequency.	50 CTCSS Tones ( <b>100 Hz</b> )
40	SQL TYPE	Selects the Tone Encoder and/or Decoder mode.	<b>OFF/TONE ENC/TONE SQL/REV TONE/DCS</b>
41	STEP	Setting of the synthesizer steps.	5.00/6.25/8.33/10.00/12.50/ 15.00/20.00/25.00/50.00/ 100.00/200.00 kHz, <b>AUTO</b>
42	STEREO	Select the audio output.	<b>STEREO/MONO</b>
43	TOT	Setting of the TOT time.	1MIN ~ 30MIN, <b>OFF</b>
44	TX POWER	Selects the transmit power output level.	<b>LOW/MID/HIGH</b>
45	VOL.ITCOM	Sets the volume level of the intercom mode.	<b>IVOL HI/IVOL LOW</b>
46	VOX MIC	Enables/Disables VOX operation.	<b>VOX OFF/R-HAND/F-HAND/FRONT</b>
47	VOX SENS	Sets the VOX sensitivity.	MIN/1/2/3/4/5/6/7/8/MAX
48	WIRES	Enable/Disable the Internet Connection feature.	<b>OFF/CODE/MEM</b>
49	WX ALERT	Enables/Disables the Weather Alert Scan feature.	<b>OFF/ON</b>

※: Depends on the band of operation.

# MENU (“SET”) MODE

REPEATER SETTING	SET MODE ITEM	AVAILABLE VALUES (DEFAULT)
Enables/Disables the Automatic Repeater Shift function.	24 RPT ARS	ON/OFF
Sets the Repeater Shift Direction.	25 RPT MODE	RPTR OFF/RPTR -/RPTR +*
Sets the magnitude of the repeater Shift.	26 RPT SFT	0.00 ~ 99.95 MHz*
CTCSS/DCS/DTMF SETTING	SET MODE ITEM	AVAILABLE VALUES (DEFAULT)
Programming of the DTMF Autodialer.	13 DTMF	—
Enables/Disables the Enhanced CTCSS Paging & Code Squelch function and setting the Receiving/Transmitting Pager Code for the Enhanced CTCSS Paging & Code Squelch function.	21 PAGER	OFF/ON
Selects the number of CTCSS/DCS/EPCS Bell ringer repetitions.	35 SQL BELL	OFF/1T/3T/5T/8T/CONT
Setting of the DCS code.	36 SQL DCS	104 Standard DCS Code (023)
Enables/Disables split CTCSS/DCS coding.	37 SQL EXP	OFF/ON
Setting of the CTCSS Tone Frequency.	39 SQL TSQF	50 standard CTCSS tones (100 Hz)
Selects the Tone Encoder and/or Decoder mode.	40 SQL TYPE	OFF/TONE ENC/TONE SQL/REV TONE/DCS
SCAN SETTING	SET MODE ITEM	AVAILABLE VALUES (DEFAULT)
Activates the Club Channel Monitor.	10 CLUB PRI	OFF/AUTO/HOLD
Selects the Scan range.	30 SCN CVRG	IN BAND/HAM BAND
Select the Scan type.	31 SCN DRCT	NORMAL/RETURN
Selects the Scan Resume mode.	32 SCN MODE	BUSY/HOLD/TIME 3S/TIME 5S/TIME 10S
Select the scan start direction which initiates the scanner using the scan command by pressing the  key.	33 SCN STRT	UP START/DN.START
Enables/Disables the Weather Alert Scan feature.	49 WX ALERT	OFF/ON
MESSAGE SETTING	SET MODE ITEM	AVAILABLE VALUES (DEFAULT)
Programming a Member List for the Message feature.	16 ID LIST	—
Sets your Personal ID for the Message feature.	17 ID REG	—
Programming a Message for the Message feature.	18 MESSAGE	—
POWER SAVE SETTING	SET MODE ITEM	AVAILABLE VALUES (DEFAULT)
Enable/Disable the battery saver of the optional BH-1 <i>Bluetooth</i> ® Headset.	7 BLU SAVE	OFF/ON
Setting of the TOT time.	43 TOT	1MIN ~ 30MIN or OFF
Selects the transmit power output level.	44 TX POWER	LOW/MID/HIGH
MIC/SPEAKER/AUDIO SETTING	SET MODE ITEM	AVAILABLE VALUES (DEFAULT)
Enables/Disables the <i>Bluetooth</i> ® function.	8 BLU VOX	OFF/PTT/VOX HIGH/VOX LOW
Adjust the microphone gain level.	19 MIC GAIN	MIN/LOW/NORMAL/HIGH/MAX
Select the Speaker to be used.	34 SPEAKER	REAR/F+R/FRONT/OFF
Select the audio output.	42 STEREO	STEREO/MONO
Sets the volume level of the intercom mode.	45 VOL.ITCOM	IVOL HI/IVOL LOW
Enables/Disables VOX operation.	46 VOX MIC	VOX OFF/R-HAND/F-HAND/FRONT
Sets the VOX sensitivity.	47 VOX SENS	MIN/1/2/3/4/5/6/7/8/MAX
DISPLAY SETTING	SET MODE ITEM	AVAILABLE VALUES (DEFAULT)
Activates/Disables the Internal Clock/Stop Watch Timer.	9 CLOCK	OFF/ON
Indicates the DC Supply Voltage.	11 DC VOLT	—
Setting of the display's illumination level.	12 DIMMER	DIMMER 1 ~ DIMMER 5

# MENU (“SET”) MODE

SWITCH/KNOB SETTING	SET MODE ITEM	AVAILABLE VALUES (DEFAULT)
Enables/Disables the beeper.	6 BEEP	<b>KEY+SC</b> /KEY/OFF
Selects the category which is recalled from the top panel  key.	14 FKEY MOD	<b>FNC</b> /FNC+MSG/MSG
Assigns a function to the Function Key.	15 FKEY SEL	AF DUAL, ARTS, DIMMER, HORN 1, HORN 2, HORN 3, HORN 4, INTERCOM, MONI, <b>PA</b> , REVERSE, SCAN, SQL LEVEL, SSCH, TCALL, TX POWER, VOL, ITCOM
Select the function of the microphone's [PGM] key.	20 MIC PRGM	TX LOW/RP TR/SQL TYP/REV/TSQL F/DCODE/MONI/TCALL/SSCH/ARTS/TAG/MHz/SCAN/CLUB/ <b>WX OFF</b> /ON
Enables/Disables the locking of the PTT key when the LOCK mode is activated.	22 PTT LOCK	<b>MOMENT</b> /TOGGLE
Selects the PTT key function.	23 PTT MODE	5.00/6.25/8.33/10.00/12.50/15.00/20.00/25.00/50.00/100.00/200.00 kHz, or <b>AUTO</b>
Setting of the synthesizer steps.	41 STEP	
WIRES SETTING	SET MODE ITEM	AVAILABLE VALUES (DEFAULT)
Enable/Disable the Internet Connection feature.	48 WIRES	<b>OFF</b> /CODE/MEM
MISCELLANEOUS SETTING	SET MODE ITEM	AVAILABLE VALUES (DEFAULT)
Enables/Disables the Automatic Audio Volume Controller.	1 AF AUTO	<b>OFF</b> /ON MIN/ON MID/ON MAX
Enables/Disables the AF DUAL operation.	2 AF DUAL	<b>OFF</b> / AM AUTO / AM HOLD/ FM AUTO/ FM HOLD/ LI AUTO / LI HOLD
Select the Tone Pitch control for the received audio.	3 AF PITCH	LOW-3/LOW-2/LOW-1/ <b>NORMAL</b> /HIGH-1/HIGH-2
Enable/Disable the Volume Setting Alert feature.	4 AF PREST	<b>OFF</b> /OV ALERT/LV ALERT/ HV ALERT
Select the DIAL knob and display function.	5 AF-VFO	TOGGLE/ <b>AUTOBACK</b>
Enables/Disables the band expansion.	27 RX EXP	<b>NORMAL</b> /EXPAND
Shifting of the CPU clock frequency.	28 RX F CCL	<b>OFF</b> /ON
Selects the receiving mode.	29 RX M MOD	<b>AUTO</b> /WIDE FM/FMNARR FM/AM
Set the squelch threshold level.	38 SQL LEVEL	SQL OFF/SQL MIN/SQL 01/SQL 02/ SQL 03/ SQL 04/ SQL 05/ SQL 06/ SQL MAX <b>Amateur Bands: SQL 01</b> <b>AM: SQL 01, FM: SQL 02</b>

※: Depends on the band of operation.

# *MENU (“SET”) MODE*

---

## Set Mode Item [F1 AF AUTO]

**Function:** Enables/Disables the Automatic Audio Volume Controller.

**Available Values:** OFF/ON MIN/ON MID/ON MAX

**Default:** OFF

ON MIN: Activates the Automatic Audio Volume Controller with the low effect level.

ON MID: Activates the Automatic Audio Volume Controller with the medium effect level.

ON MAX: Activates the Automatic Audio Volume Controller with the high effect level.

OFF: Disable the Automatic Audio Volume Controller.

## Set Mode Item [F2 AF DUAL]

**Function:** Enables/Disables the AF DUAL operation.

**Available Values:** OFF/AM AUTO/AM HOLD/FM AUTO/FM HOLD/LI AUTO/LI HOLD

**Default:** OFF

AM AUTO: You may listen to the AM Broadcast station while monitoring an amateur band frequency. When a signal is received on the amateur band, the **FTM-10R** will receive the amateur band signal. When the amateur signal drops, the AM station will be heard. The **FTM-10R** will return to the AF Dual function.

AM HOLD: You may listen to an AM Broadcast station, while monitoring an amateur band frequency. When a signal is received on the amateur band, the **FTM-10R** will continuously receive the amateur band, and will not restart the AF Dual function.

FM AUTO: You may listen to the FM Broadcast station, while monitoring an amateur band frequency. When a signal is received on the amateur band, the **FTM-10R** will receive the amateur band signal. When the amateur signal drops, the FM Broadcast station will be heard. The **FTM-10R** will return to the AF Dual function.

FM HOLD: You may listen to the FM Broadcast station while monitoring an amateur band frequency. When a signal is received on the amateur band, the **FTM-10R** will continuously receive the amateur band, and will not restart the AF Dual function.

LI AUTO: You may listen to the line audio, while monitoring an amateur band frequency. When a signal is received on the amateur band, the **FTM-10R** will receive the amateur band signal. When the amateur signal drops, the line audio will be heard. The **FTM-10R** will return to the AF Dual function.

LI HOLD: You may listen to the line audio, while monitoring an amateur band frequency. When a signal is received on the amateur band, the **FTM-10R** will continuously receive the amateur band, and will not restart the AF Dual function.

# MENU (“SET”) MODE

---

## Set Mode Item [F3 AF PITCH]

**Function:** Select the Tone Pitch control for the received audio.

**Available Values:** LOW-3/LOW-2/LOW-1/NORMAL/HIGH-1/HIGH-2

**Default:** NORMAL

## Set Mode Item [F4 AF PREST]

**Function:** Enable/Disable the Volume Setting Alert feature.

**Available Values:** OFF/OV ALERT/LV ALERT/ HV ALERT

**Default:** OFF

OV ALERT: Activates the Volume Setting Alert feature. A lamp at the left of the **DIAL** knob blinks orange when volume level is set to the  $\pm 3$  steps of the preset level.

LV ALERT: Activates the Volume Setting Alert feature. A lamp at the left of the **DIAL** knob blinks orange when volume level is set to the preset level minus 3 steps.

HV ALERT: Activates the Volume Setting Alert feature. A lamp at the left of the **DIAL** knob blinks orange when volume level is set to the preset level plus 3 steps above.

OFF: Disables the Volume Setting Alert feature.

## Set Mode Item [F5 AF-VFO]

**Function:** Select the DIAL knob and display function.

**Available Values:** TOGGLE/AUTOBACK

**Default:** AUTOBACK

TOGGLE: Keeps the **DIAL** knob function and display until the [VOL/SEL] key is pressed once again.

AUTOBACK: The **DIAL** knob function and display comes back to frequency selection and frequency display after approximately 3 seconds.

## Set Mode Item [F6 BEEP]

**Function:** Enables/Disables the beeper.

**Available Values:** KEY+SC/KEY/OFF

**Default:** KEY+SC

KEY+SC: The beeper sounds when you press any key, or when the scanner stops.

KEY: The beeper sounds when you press any key.

OFF: Beeper is disabled.

## Set Mode Item [F7 BLU SAVE]

**Function:** Enable/Disable the battery saver of the optional BH-1 Bluetooth® Headset.

**Available Values:** OFF/ON

**Default:** OFF

# MENU (“SET”) MODE

---

## Set Mode Item [F8 BLU VOX]

**Function:** Enables/Disables the **Bluetooth**® function (requires the optional BU-1 **Bluetooth**® Unit).

**Available Values:** OFF/PTT/VOX HIGH/VOX LOW

**Default:** PTT

OFF: Disable the **Bluetooth**® function.

PTT: Activate **Bluetooth**® function without the VOX feature.

VOX HIGH: Activate **Bluetooth**® function with the VOX feature (VOX gain: High).

VOX LOW: Activate **Bluetooth**® function with the VOX feature (VOX gain: Low).

## Set Mode Item [F9 CLOCK]

**Function:** Activates/Disables the Internal Clock/Stop Watch Timer.

**Available Values:** OFF/ON

**Default:** OFF

## Set Mode Item [F10 CLUB PRI]

**Function:** Activates the Club Channel Monitor.

**Available Values:** OFF/AUTO/HOLD

**Default:** OFF

OFF: Disables the Club Channel Monitor feature.

AUTO: When the **FTM-10R** receives a signal on the Club Channel, the Club Channel audio is heard. Five seconds after the Club Channel signal drops, Club Channel Monitor resumes.

HOLD: When a signal is received on the Club Channel, the **FTM-10R** will receive the Club Channel continuously, and will not restart the Club Channel monitor.

## Set Mode Item [F11 DC VOLT]

**Function:** Indicates the DC Supply Voltage.

## Set Mode Item [F12 DIMMER]

**Function:** Setting of the display's illumination level.



**Available Values:** DIMMER 1 - DIMMER 5

**Default:** 5

## Set Mode Item [F13 DTMF]

**Function:** Programming of the DTMF Autodialer. See page 72 for details.

## Set Mode Item [F14 FKEY MOD]

**Function:** Selects the category which is recalled from the top panel / key.

**Available Values:** FNC/FNC+MSG/MSG

**Default:** FNC

FNC: Recalls the Public Address feature, Horn Alert Feature, and other features.

FNC+MSG: Recalls the Public Address feature, Horn Alert Feature, Message, and other features.

MSG: Recall the message only.



# *MENU (“SET”) MODE*

---

## Set Mode Item [F15 FKEY SEL]

**Function:** Assigns a function to the Function Key.

**Available Values:** AF DUAL, ARTS, DIMMER, HORN 1, HORN 2, HORN 3, HORN 4, INTERCOM, MONI, PA, REVERSE, SCAN, SQL LEVEL, SSCH, TCALL, TX POWER, VOL.ITCOM

**Default:** PA

## Set Mode Item [F16 ID LIST]

**Function:** Programming a Member List for the Message feature. See page 47 for details.

## Set Mode Item [F17 ID REG]

**Function:** Sets your Personal ID for the Message feature. See page 49 for details.

## Set Mode Item [F18 MESSAGE]

**Function:** Programming a Message for the Message feature. See page 46 for details..

## Set Mode Item [F19 MIC GAIN]

**Function:** Adjust the microphone gain level.

**Available Values:** MIN/LOW/NORMAL/HIGH/MAX

**Default:** NORMAL

## Set Mode Item [F20 MIC PRGM]

**Function:** Select the function of the microphone's [PGM] key.

**Available Values:** TX LOW/RPTR/SQLTYP/REV/TSQLF/DCODE/MONI/TCALL/SSCH/ARTS/TAG/MHz/SCAN/CLUB/WX

**Default:** WX

## Set Mode Item [F21 PAGER]

**Function:** Enables/Disables the Enhanced CTCSS Paging & Code Squelch function and setting the Receiving/Transmitting Pager Code for the Enhanced CTCSS Paging & Code Squelch function.

**Available Values:** OFF/ON

**Default:** OFF

## Set Mode Item [F22 PTT LOCK]

**Function:** Enables/Disables the locking of the PTT key when the LOCK mode is activated.

**Available Values:** OFF/ON

**Default:** OFF

## Set Mode Item [F23 PTT MODE]

**Function:** Selects the PTT key function.

**Available Values:** MOMENT/TOGGLE

**Default:** MOMENT

# ***MENU (“SET”) MODE***

---

## **Set Mode Item [F24 RPT ARS]**

**Function:** Enables/Disables the Automatic Repeater Shift function.

**Available Values:** ON/OFF

**Default:** ON

## **Set Mode Item [F25 RPT MODE]**

**Function:** Sets the Repeater Shift Direction.

**Available Values:** RPTR OFF/RPTR -/RPTR +

**Default:** Depends on the transceiver version, as well as the setting of Menu Item [F24 RPT ARS].

## **Set Mode Item [F26 RPT SFT]**

**Function:** Sets the magnitude of the repeater Shift.

**Available Values:** 0.00 - 99.95 MHz (50 kHz increments)

**Default:** Depends on the operating band and transceiver version.

## **Set Mode Item [F27 RX EXP]**

**Function:** Enables/Disables the band expansion.

**Available Values:** NORMAL/EXPAND

**Default:** NORMAL

When this Set Mode Item is set to “EXPAND”, you will receive the following additional bands.

108 - 137 MHz	300 - 336 MHz	470 - 800 MHz
174 - 200 MHz	336 - 420 MHz	800 - 999.9875 MHz (cellular blocked)

## **Set Mode Item [F28 RX F CCL]**

**Function:** Shifting of the CPU clock frequency.

**Available Values:** OFF/ON

**Default:** OFF

This function is only used to move a spurious response “birdie”, should it fall on a desired frequency.

## **Set Mode Item [F29 RX M MOD]**

**Function:** Selects the receiving mode.

**Available Values:** AUTO/WIDE FM/FMNARR FM/AM

**Default:** AUTO

# MENU (“SET”) MODE

---

## Set Mode Item [F30 SCN CVRG]

**Function:** Selects the Scan range.

**Available Values:** IN BAND/HAM BAND

**Default:** IN BAND

**IN BAND:** The **FTM-10R** considers the 144 MHz Amateur Band and 430 MHz Amateur Band to be independent bands, and scans only the 144 MHz Amateur Band, or only the 430 MHz Amateur Band.

**HAM BAND:** The **FTM-10R** considers the 144 MHz Amateur Band and 430 MHz Amateur Band to be one band and scans it when the scan mode is engaged.

Activate the scanner across the 144 MHz Amateur Band and 430 MHz Amateur Band.

## Set Mode Item [F31 SCN DRCT]

**Function:** Select the Scan type.

**Available Values:** NORMAL/RETURN

**Default:** NORMAL

**NORMAL:** When the VFO frequency reaches the high band edge of the current band, the VFO frequency will jump to the low band edge of the current band (or vice versa).

**RETURN:** When the VFO frequency reaches the high band edge of the current band while scanning upward, the scanner will reverse direction and scan downwards. (or vice versa).

## Set Mode Item [F32 SCN MODE]

**Function:** Selects the Scan Resume mode.

**Available Values:** BUSY/HOLD/TIME 3S/TIME 5S/TIME 10S

**Default:** BUSY

**BUSY:** The scanner will hold until the signal disappears, then will resume when the carrier drops.

**HOLD:** The scanner will stop when a signal is received, and will not restart.

**TIME 3S/5S/10S:** The scanner will hold for selected resume time, then resume whether or not the other station is still transmitting.

## Set Mode Item [F33 SCN STRT]

**Function:** Select the scan start direction which initiates the scanner using the scan command by pressing the  key.

**Available Values:** UP START/DN.START

**Default:** UP START

# ***MENU (“SET”) MODE***

---

## **Set Mode Item [F34 SPEAKER]**

**Function:** Select the Speaker to be used.

**Available Values:** REAR/F+R/FRONT/OFF

**Default:** REAR

**REAR:** Outputs the receiving audio from the REAR speaker (located in the transceiver's body).

**F+R:** Outputs the receiving audio from both FRONT (located in the front panel) and REAR speakers.

**FRONT:** Outputs the receiving audio from the FRONT (located in the front panel) speaker.

**OFF:** Disable the FRONT and REAR Speakers.

## **Set Mode Item [F35 SQL BELL]**

**Function:** Selects the number of CTCSS/DCS/EPCS Bell ringer repetitions.

**Available Values:** OFF/1T/3T/5T/8T/CONT (Continuous ringing)

**Default:** OFF

## **Set Mode Item [F36 SQL DCS]**

**Function:** Setting of the DCS code.

**Available Values:** 104 standard DCS codes

**Default:** DCS(023)

## **Set Mode Item [F37 SQL EXP]**

**Function:** Enables/Disables split CTCSS/DCS coding.

**Available Values:** OFF/ON

**Default:** OFF

When this Set Mode Item is set to “ON”, you will see the following additional parameters after the “DCS” parameter while configuring Menu Item “F40 SQL TYPE”.

**DCS ENC:** DCS Encode only.

**TONE DCS:** Encodes a CTCSS tone and Decodes a DCS code.

**DCS TSQL:** Encodes a DCS code and Decodes a CTCSS tone.

Select the desired operating mode from the selections shown above.

## **Set Mode Item [F38 SQL LEVL]**

**Function:** Set the squelch threshold level.

**Available Values:** SQL OFF/SQL MIN/SQL 01/SQL 02/ SQL 03/ SQL 04/ SQL 05/ SQL 06/ SQL MAX

**Default:** Amateur Bands: SQL 01, AM: SQL 01, FM: SQL 02

# MENU (“SET”) MODE

---

## Set Mode Item [F39 SQL TSQF]

**Function:** Setting of the CTCSS Tone Frequency.

**Available Values:** 50 standard CTCSS tones

**Default:** 100.0 Hz

## Set Mode Item [F40 SQL TYPE]

**Function:** Selects the Tone Encoder and/or Decoder mode.

**Available Values:** OFF/TONE ENC/TONE SQL/REV TONE/DCS/

**Default:** OFF

TONE ENC: CTCSS Encoder

TONE SQL: CTCSS Encoder/Decoder

REV TONE: Reverse CTCSS Decoder (Mutes receiver when matching tone is received)

DCS: Digital Coded Encoder/Decoder

**Note:** See also Menu Item “F37 SQL EXP” regarding additional selections available during “Split Tone” operation.

## Set Mode Item [F41 STEP]

**Function:** Setting of the synthesizer steps.

**Available Values:** 5.00/6.25/8.33/10.00/12.50/15.00/20.00/25.00/50.00/100.00/200.00 kHz, or AUTO

**Default:** AUTO (Step automatically changes according to operating frequency.)

Note: 1) AM BC band only selects 9 kHz or 10 kHz.

Note: 2) FM BC band only selects 50 kHz, 100 kHz, or 200 kHz.

Note: 3) Steps of 5 kHz, 6.25 kHz, 8.33kHz, and 9 kHz are not available above 470 MHz.

## Set Mode Item [F42 STEREO]

**Function:** Select the audio output.

**Available Values:** STEREO/MONO

**Default:** MONO

## Set Mode Item [F43 TOT]

**Function:** Setting of the TOT time

**Available Values:** 1MIN - 30MIN or OFF

**Default:** OFF

The time-out timer shuts off the transmitter after continuous transmission of the programmed time.

## Set Mode Item [F44 TX POWER]

**Function:** Selects the transmit power output level.

**Available Values:** LOW/MID/HIGH

**Default:** HIGH

# ***MENU (“SET”) MODE***

---

## **Set Mode Item [F45 VOL.ITCOM]**

**Function:** Sets the volume level of the intercom mode.

**Available Values:** IVOL HI/IVOL LOW

**Default:** IVOL HI

## **Set Mode Item [F46 VOX MIC]**

**Function:** Enables/Disables VOX operation.

**Available Values:** VOX OFF/R-HAND/F-HAND/FRONT

**Default:** VOX OFF

VOX OFF: Disable the VOX operation

R-HAND: Enable the VOX operation for the microphone, which is connected to the rear panel MIC Jack.

F-HAND: Enable the VOX operation for the microphone, which is connected to the front panel MIC Jack (requires optional “**MEK-M10**” Microphone Jack).

FRONT: Enable the VOX operation for the front panel microphone.

## **Set Mode Item [F47 VOX SENS]**

**Function:** Sets the VOX sensitivity.

**Available Values:** MIN/1/2/3/4/5/6/7/8/MAX

**Default:** 5

## **Set Mode Item [F48 WIRES]**

**Function:** Enable/Disable the Internet Connection feature.

**Available Values:** OFF/CODE/MEM

**Default:** OFF

## **Set Mode Item [F49 WX ALERT]**

**Function:** Enables/Disables the Weather Alert Scan feature.

**Available Values:** OFF/ON

**Default:** OFF

---

## MH-68B6J MICROPHONE (OPTION)

---

### ① PTT Switch

Press this switch to transmit, and release it to receive.

### ② DWN/UP keys

Press (or hold in) either of these keys to tune (or scan up or down) the operating frequency or through the memory channels. In many ways, these keys emulate the function of the **FTM-10R's** **DIAL** knob.

### ③ PGM key

Press this key to recall the Weather Broadcast Station Memory Bank. You may program the configuration of this key, to enable use a different function, via Menu Item "F20 MIC PRGM". See page 79 for details.

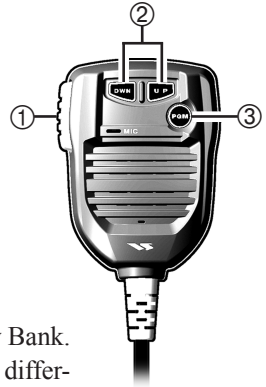

---

## MH-68A6J MICROPHONE (OPTION)

---

### ① PTT Switch

Press this switch to transmit, and release it to receive.

### ② DWN/UP keys

Press (or hold in) either of these keys to tune (or scan up or down) the operating frequency or through the memory channels. In many ways, these keys emulate the function of the **FTM-10R's** **DIAL** knob.

### ③ PGM key

Press this key to recall the Weather Broadcast Station Memory Bank. You may program the configuration of this key, to enable use a different function, via Menu Item "F20 MIC PRGM". See page 79 for details.

### ④ Keypad

[1] ~ [0] keys

This key generates the DTMF "1" ~ "0" tone during transmission, and frequency entry digit "1" ~ "0" during Direct keypad Frequency Entry.

[A] ~ [D], [\*], [#] keys

[A] ➡ This key emulates the function of the **FTM-10R's** front panel key.

[B] ➡ This key emulates the function of the **FTM-10R's** front panel key.

[C] ➡ This key emulates the function of the **FTM-10R's** front panel key.

[D] ➡ This key emulates the function of the **FTM-10R's** front panel [VOL/SEL] key.

[\*] ➡ This key emulates the function of the **FTM-10R's** top panel key.

[#] ➡ This key emulates the function of the **FTM-10R's** top panel key.

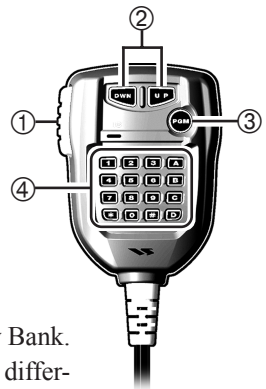

# INSTALLATION OF OPTIONAL ACCESSORIES

## MICROPHONE JACK "MEK-M10"

1. Remove the four screws securing the Front Panel and then remove the Front Panel from the Transceiver Body.

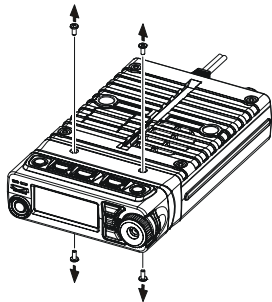

2. Disconnect the 8-pin modular plug from the Transceiver.

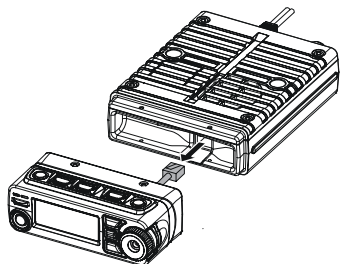

3. Remove the screw affixing the Straight Sub Panel, and then remove the Straight Sub Panel from the Front Panel.

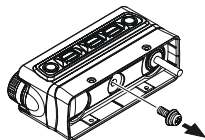

4. Remove the two screws affixing the Microphone Jack cover, and then remove the Microphone Jack cover from the Front Panel.

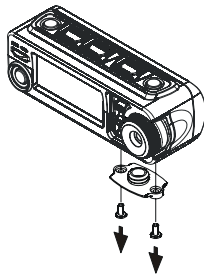

5. Remove the four screws securing the Rear Case of the Front Panel and remove the Rear Case from the Front Panel.

*Note:* When you remove the rear case, you will find a small thin wire near the flat ribbon cable. Be careful not to cut or add any stress to this wire. It will be connected in step 7.

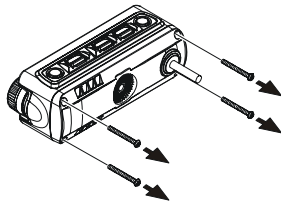



# INSTALLATION OF OPTIONAL ACCESSORIES

## MICROPHONE JACK “MEK-M10”

6. Attach the “**MEK-M10**” to the Front Panel using the previously removed two screws.

*Note:* When securing the **MEK-M10** to the front panel, make sure that the rubber gasket is free of any contaminants and properly seated before securing the **MEK-M10** with the screws. This will insure that moisture or water does not enter the front panel.

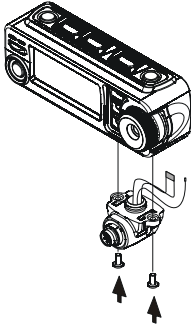

7. Attach the Flat cable to the connector on the Printed Circuit Board, and connect the Wire from the “**MEK-M10**” to the Wire from the Printed Circuit Board in the front panel.

*Note:* Please adjust the terminal side of the flat cable to the lower side of the connector on the Printed Circuit Board, and insert it in the connector.

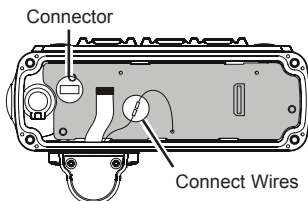

8. Replace the Rear Case, Sub Panel, and 8-pin modular plug.
9. Attach the Front Panel to the Transceiver Body using the previously removed four screws.

# INSTALLATION OF OPTIONAL ACCESSORIES

## BU-1 Bluetooth® ADAPTER UNIT

Please be sure to follow these safety precautions:

- Turn the transceiver power off, and disconnect all cables from the transceiver.
- Touch a metal place to discharge any static electricity from your body.

### Installing the “BU-1” in the Front Panel

1. Remove the four screws securing the Front Panel and then remove the Front Panel from the Transceiver Body.

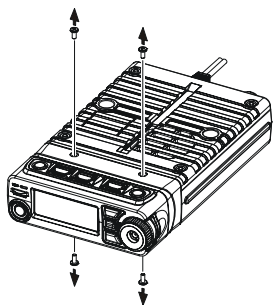

2. Disconnect the 8-pin modular plug from the Transceiver.

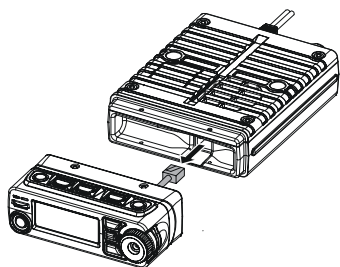

3. Remove the screw affixing the Straight Sub Panel, and then remove the Straight Sub Panel from the Front Panel.

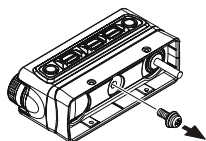

4. Remove the four screws securing the Rear Case of the Front Panel and remove the Rear Case from the Front Panel.

*Note:* When you remove the rear case, you will find a small thin wire near the flat ribbon cable. Be careful not to cut or damage this wire. It will be connected in step 6.

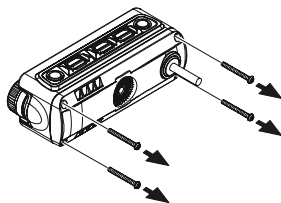

5. Carefully align the connector on the BU-1 with the connector on the Printed Circuit Board, and gently press the **BU-1** into place.

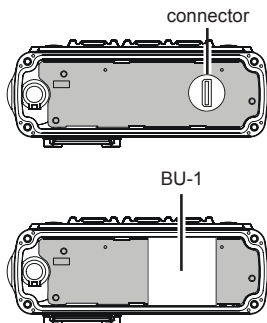

6. Replace the Rear Case, Sub Panel, and 8-pin modular plug.
7. Attach the Front Panel to the Transceiver Body using the previously removed four screws.

# INSTALLATION OF OPTIONAL ACCESSORIES

## BU-1 Bluetooth® ADAPTER UNIT

### Installing the “BU-1” in the Transceiver Body

1. Remove the four screws securing the Front Panel and then remove the Front Panel from the Transceiver Body.

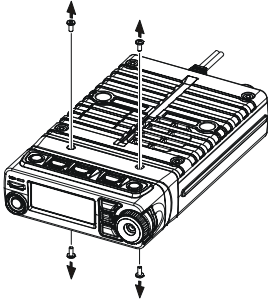

2. Disconnect the 8-pin modular plug from the Transceiver.

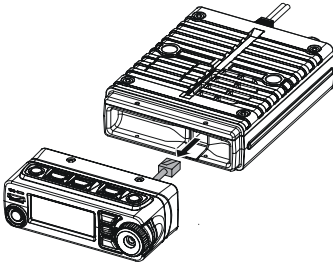

3. Remove the four HEX bolts securing the Top case and carefully separate the Top case from the Transceiver Body.

**Note:** When you remove the top case, you will find a small thin wire. Be careful not to cut or damage this wire. It will be connected in step 5.

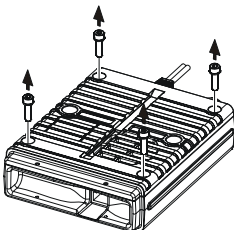

4. Carefully align the connector on the **BU-1** with the connector on the Printed Circuit Board, and gently press the **BU-1** into place.

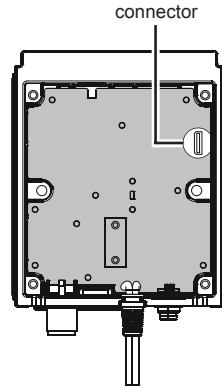

5. Replace the Top Case, the HEX bolts and the 8-pin modular plug.
6. Attach the Front Panel to the Transceiver Body using the previously removed four screws.

# *INSTALLATION OF OPTIONAL ACCESSORIES*

## **CAB-1 Bluetooth® HEAD SET CHARGER SLEEVE**

1. Peel off the blind seal on the Front Panel.

Peel off the blind seal

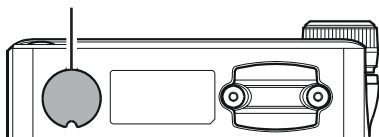

2. Attach the “**CAB-1**” to the Front Panel using the supplied two screws.

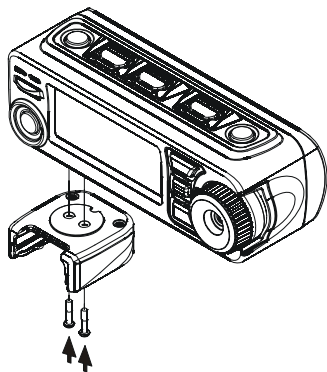

# *RESET PROCEDURE*

---

Static electricity may occasionally cause erratic or unpredictable operation of the microprocessor. If this happens, resetting of the microprocessor may restore normal operation. Note that resetting the microprocessor will erase all memories.

1. Turn the radio off.
2. Press and hold in the [VOL/SEL] key while turning the radio on.
3. Rotate the **DIAL** knob to one of the following Reset Menu items:

SF1 COPY ALL: Transfer all memories and other settings from a transceiver to another **FTM-10R**. This is not a reset operation.

SF2 COPY MSG: Transfer all messages from a transceiver to another **FTM-10R**. This is not a reset operation.

SF3 RSET MSG: Resets the messages to factory defaults.

SF4 RSET SYS: Resets the Menu Item settings to their factory defaults.  
(Except F16 ID LIST, F17 ID REG, F18 MESSAGE, F25 RPT MODE, F26 RPT SFT, F28 RX F CCL, F36 SQL DCS, F39 SQL TSGF, F40 SQL TYPE, and F44 TX POWER)

SF5 RSET ALL: Clears all memories and other settings to factory defaults.

SF6 BLTH R: Set up the **Bluetooth**® device which is connected to the transceiver. This is not a reset operation.

SF7 BLTH F: Set up the **Bluetooth**® device which is connected to the front panel of the transceiver. This is not a reset operation.

4. Once you have made your selection in step 3, press the **PTT** key and confirm that (YES) is displayed on the LCD. Press the **PTT** key once more to complete the reset procedure. (To cancel the reset procedure, turn the transceiver off before pressing the **PTT** key.)

# ***TROUBLESHOOTING***

---



## **The LED at the left side of the DIAL knob Blinks in Yellow**

- The Volume Setting Alert feature is turned on.  
Set the Menu Item “F4 AF PREST” to “OFF”. See Page 86

## **Receiver audio volume level changes automatically**

- The Automatic Audio Volume Controller is turned on.  
Set the Menu Item “F1 AF AUTO” to “OFF”. See Page 56

## **No transmit even if pressing the PTT key**

- PA feature or Horn Alert feature is turned on.  
Turn off these features by the Top panel’s / /  keys.
- PTT Lock feature is turned on.  
Set the Menu Item “F22 PTT LOCK” to “OFF”. See Page 87

## **Does not revert to receive after releasing the PTT key**

- PTT mode is set to TOGGLE.  
Set the Menu Item “F23 PTT MODE” to “MOMENT”. See Page 77

## **Transmission begins automatically without pressing the PTT key**

- VOX feature is set to on.  
Set the Menu Item “F46 VOX MIC” to “OFF”. See Page 57

## **Sound is not emitted from the internal or external speaker**

- Speaker selection is set to “Front”.  
Set the Menu Item “F34 SPEAKER” to “REAR” or “F+R”. See Page 86

## **Cannot recall the memory channel data on the Group memory**

- The memory channel has been eliminated from the memory group  
Re-assign the eliminated memory channel via the Menu Item “M1 GROUP”. See Page 36

# SPECIFICATIONS

---

## General

<b>Frequency Range:</b>	RX: 0.5 - 1.8 MHz (AM BC) 76 - 108 MHz (FM BC) 108-137 MHz (Air Band) 137-174 MHz (144 MHz HAM) 174-222 MHz (GR1 VHF TV) 300-420 MHz (GR2 ) 420-470 MHz (430 MHz HAM) 470-800 MHz (GR1 UHF TV) 800-999 MHz (GR2 USA Cellular Blocked) TX: 144.000 - 148.000 MHz or 144.000 - 146.000 MHz, 430.000 - 450.000 MHz or 430.000 - 440.000 MHz
<b>Channel Steps:</b>	5/6.25/8.33/(9)/10/12.5/15/20/25/50/100/200 kHz (9): AM Only
<b>Emission Type:</b>	F3E, F2D, F1D
<b>Antenna Impedance:</b>	50 Ohms
<b>Frequency Stability:</b>	±5 ppm @ 14 °F ~ +140 °F (-10 °C ~ +60 °C)
<b>Operating Temperature Range:</b>	-4 °F ~ +140 °F (-20 °C ~ +60 °C)
<b>Supply Voltage:</b>	Nominal: 13.8 V DC, Negative Ground Operating: 11.7 ~ 15.8 V, Negative Ground
<b>Current Consumption:</b> (Approx.)	RX: 0.5 A (Receive) 8.3 A / 6 A / 2A (TX, 144 MHz 50W / 20 W / 5 W) 8.5 A / 6 A / 2A (TX, 430 MHz 40W / 20 W / 5 W)
<b>Case Size (W x H x D):</b>	4.4" x 1.5" x 7" (112 x 37.6 x 178 mm) (w/o knobs & connectors)
<b>Weight (Approx.):</b>	2.9 lb. (1.3 kg)

## Transmitter

<b>RF Power Output:</b>	50/20/5 W (144 MHz) 40/20/5 W (430 MHz)
<b>Modulation Type:</b>	Variable Reactance
<b>Maximum Deviation:</b>	±5 kHz
<b>Spurious Radiation:</b>	At least -60 dB below
<b>Microphone Impedance:</b>	2 kΩ

# SPECIFICATIONS

---

## Receiver

<b>Circuit Type:</b>	FM / AM: Double-Conversion Super heterodyne WFM: Triple-Conversion Super heterodyne AM / FM Radio: Single-Conversion Super heterodyne
<b>Intermediate Frequencies:</b>	FM / AM: 1st: 47.25 MHz, 2nd: 450 kHz WFM: 1st: 45.8 MHz, 2nd: 10.7MHz, 3rd: 1MHz FM Radio: 130 kHz, AM Radio: 50 kHz
<b>Sensitivity:</b>	5 $\mu$ V TYP for 10 dB SN (0.5-1.7 MHz, AM) 2 $\mu$ V TYP for 12 dB SINAD (76-108 MHz, WFM) 0.8 $\mu$ V TYP for 10 dB SN (108-137 MHz, AM) 0.2 $\mu$ V for 12 dB SINAD (137-140 MHz, FM) 0.2 $\mu$ V for 12 dB SINAD (140-150 MHz, FM) 0.25 $\mu$ V for 12 dB SINAD (150-174 MHz, FM) 1 $\mu$ V TYP for 12 dB SINAD (174-222 MHz, WFM) 0.8 $\mu$ V TYP for 10 dB SN (300-336 MHz, AM) 0.25 $\mu$ V TYP for 12 dB SINAD (336-420 MHz, FM) 0.2 $\mu$ V for 12 dB SINAD (420-470 MHz, FM) 5 $\mu$ V TYP for 12 dB SINAD (470-540 MHz, WFM) 5 $\mu$ V TYP for 12 dB SINAD (540-800 MHz, WFM) 0.4 $\mu$ V TYP for 12 dB SINAD (800-899.99 MHz, FM) 0.8 $\mu$ V TYP for 12 dB SINAD (900 - 999.99 MHz, FM) USA Version Cellular Blocked
<b>Squelch Sensitivity:</b>	Better than 0.16 $\mu$ V (144 / 430 MHz Band)
<b>Selectivity :</b>	NFM, AM 12 kHz / 30 kHz (-6 dB / -60 dB)
<b>AF Output:</b>	8 W @ 4 Ohm for 10 % THD (@ 13.8 V) BTL EXP SP 4 W @ 4 Ohm for 10 % THD (@ 13.8 V) Normal EXP SP/CH
<b>AF Output Impedance:</b>	4-16 $\Omega$

*Specifications are subject to change without notice, and are guaranteed within the 144 and 430 MHz amateur bands only. Frequency ranges will vary according to transceiver version; check with your dealer.*





# ***NOTE***

---

1. Changes or modifications to this device not expressly approved by VERTEX STANDARD could void the user's authorization to operate this device.
2. This device complies with part 15 of the FCC Rules. Operation is subject to the following two conditions; (1) This device may not cause harmful interference, and (2) this device must accept any interference including received, interference that may cause undesired operation.
3. The scanning receiver in this equipment is incapable of tuning, or readily being altered, by the User to operate within the frequency bands allocated to the Domestic public Cellular Telecommunications Service in Part 22.

Part 15.21: Changes or modifications to this device not expressly approved by Vertex Standard could void the user's authorization to operate this device.

#### **DECLARATION BY MANUFACTURER**

The Scanner receiver is not a digital scanner and is incapable of being converted or modified to a digital scanner receiver by any user.

**WARNING:** MODIFICATION OF THIS DEVICE TO RECEIVE CELLULAR RADIOTELEPHONE SERVICE SIGNALS IS PROHIBITED UNDER FCC RULES AND FEDERAL LAW.



Copyright 2007  
VERTEX STANDARD CO., LTD.  
All rights reserved.

No portion of this manual  
may be reproduced  
without the permission of  
VERTEX STANDARD CO., LTD.

Printed in Japan

