

This service manual (B51-8956-00) has been revised due to the modification of the Final Transistor and issues it as a supplemental manual.

This service manual applies to products with A8B00001 or subsequent serial numbers. Refer to the TK-6110 service manual for any information which has not been covered in this manual.



CONTENTS

SYSTEM SETUP	2	PC BOARD	
DISASSEMBLY FOR REPAIR	2	TX-RX UNIT (X57-6100-XX)	20
PARTS LIST	3	TX-RX SECTION	20
EXPLODED VIEW	13	DISPLAY SECTION	24
PACKING	14	SCHEMATIC DIAGRAM	26

TK-6110

Document Copyrights

Copyright 2011 by Kenwood Corporation. All rights reserved.

No part of this manual may be reproduced, translated, distributed, or transmitted in any form or by any means, electronic, mechanical, photocopying, recording, or otherwise, for any purpose without the prior written permission of Kenwood.

Disclaimer

While every precaution has been taken in the preparation of this manual, Kenwood assumes no responsibility for errors or omissions. Neither is any liability assumed for damages resulting from the use of the information contained herein. Kenwood reserves the right to make changes to any products herein at any time for improvement purposes.

SYSTEM SET-UP

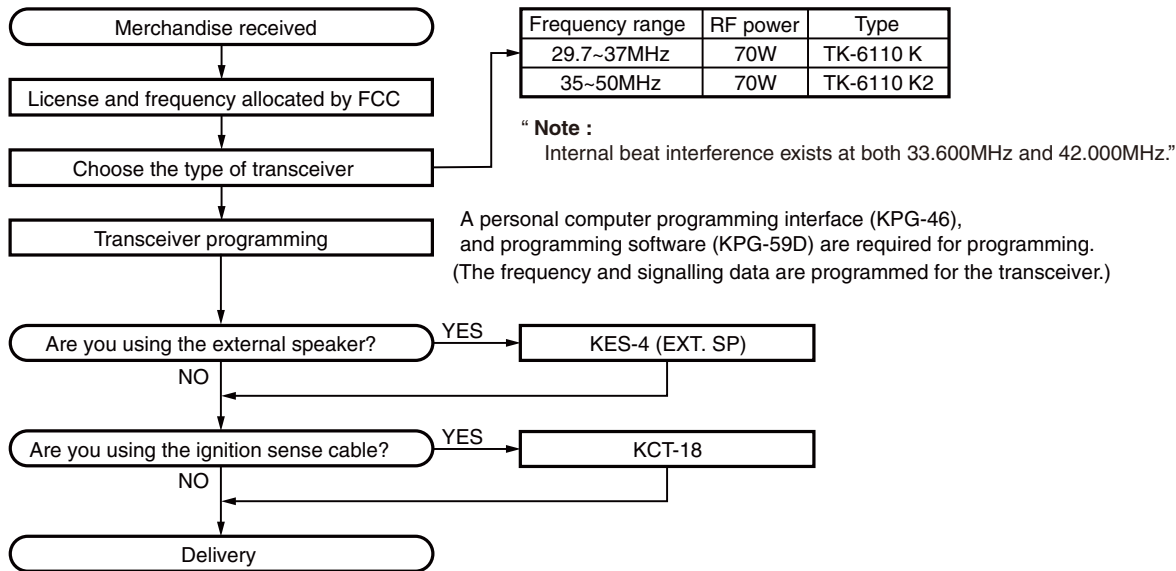

DISASSEMBLY FOR REPAIR

Compatibility information

The Final transistor (Q5,6:2SC2540) has been discontinued by the supplier, so New Final transistor (2SC2782A) has been applied on to X57-6100-XX production.

TK-6110 K,K2 (TX-RX Unit : X57-6100-XX)				
Ref.	Part Name	OLD Part S/No. 91200110 and before	NEW Part S/No. A8B00001 onwards	Compatibility
Q5,Q6	Final transistor	2SC2540	2SC2782A	No
—	PC board (X57-6100-XX)	J72-0720-x2	J79-0225-x9	No

PARTS LIST

New Parts. Δ indicates safety critical components.

Parts without **Parts No.** are not supplied.

Les articles non mentionnés dans le **Parts No.** ne sont pas fournis.

Teile ohne **Parts No.** werden nicht geliefert.

L : Scandinavia

K : USA

P : Canada

Y : PX (Far East, Hawaii)

T : England

E : Europe

C : China

X : Australia

M : Other Areas

TK-6110

TX-RX UNIT (X57-6100-XX)

Ref. No.	Address	New parts	Parts No.	Description	Desti-nation
TK-6110					
1	1B	*	A01-2170-23	METALLIC CABINET	
2	3A	*	A62-0761-13	PANEL ASSY	
3	3B		B41-1837-04	CAUTION STICKER	
7	1B	*	B41-1856-04	CAUTION STICKER	
8	2B		B42-2455-04	STICKER M4X8 MAX	
9	2B		B42-5650-04	SERIAL NUMBER STICKER	
11	1C	*	B62-1216-10	INSTRUCTION MANUAL ACCESSORY	
12	2B		B72-1633-04	MODEL NAME-PLATE	K
12	2B	*	B72-1729-24	MODEL NAME-PLATE	K2
15	2B		E30-2145-25	ANTENNA CABLE	
16	1D		E30-3339-15	DC CORD ACCESSORY	
17	1D		E31-3228-05	LEAD WIRE WITH CONNECTOR ACCESSORY	
18	3A		E37-0831-05	FLAT CABLE (MIC&VOL UNIT:13P)	
19	2A	*	E37-0833-15	LEAD WIRE WITH CONNECTOR (SP)	
20	2B	*	E37-0838-15	LEAD WIRE WITH CONNECTOR (15P)	
21	3A	*	E37-1456-05	FLAT CABLE (DISPLAY UNIT:17P)	
24	1A		F10-2370-04	SHIELDING PLATE	
25	2B	*	F12-0491-04	SHIELDING SHEET	
27	1D		F51-0080-05	FUSE (6X30 20A) ACCESSORY	
29	1A		G02-0715-04	FLAT SPRING	
30	1A		G02-0861-04	FLAT SPRING	
31	2A	*	G10-1242-04	FIBROUS SHEET (CHASSIS UPPER)	
32	3B	*	G10-1245-04	FIBROUS SHEET (CHASSIS SP)	
33	2A, 2B	*	G10-1253-04	FIBROUS SHEET (CHASSIS SIDE)	
34	1B	*	G10-1270-04	FIBROUS SHEET (CASE)	
35	3B	*	G10-1271-04	FIBROUS SHEET (CHASSIS LOWER)	
36	2B	*	G11-2613-04	RUBBER SHEET	
37	2B		G13-1468-04	CUSHION (CHASSIS REAR)	
38	2B		G13-1752-04	CUSHION (SP)	
40	3B	*	G13-1843-04	CUSHION (SP WIRE)	
41	3B		G53-0893-03	PACKING (SP)	
42	1B		G53-1509-03	PACKING (CASE)	
44	2D	*	H02-0616-03	INNER CARTON CASE	
45	2C	*	H12-3083-12	PACKING FIXTURE (FRONT)	
46	2C	*	H12-3084-12	PACKING FIXTURE (REAR)	
66	1C	*	H21-0768-04	PROTECTION SHEET	
47	2C		H25-0723-04	PROTECTION BAG (230/400/0.07)	
48	3C		H52-1504-02	ITEM CARTON CASE	
50	1D		J19-1584-15	HOLDER ACCESSORY	
51	2B		J21-8387-04	HARDWARE FIXTURE (15P CONNECTOR)	
52	2B		J21-8388-04	HARDWARE FIXTURE (SP)	
54	1D		J29-0726-03	BRACKET ACCESSORY	
55	1B	*	J42-0515-05	BUSHING (15P CONNECTOR)	
57	2B		J99-0356-04	ADHESIVE SHEET (SP)	
59	3A		K29-5388-02	KEY TOP	
60	3A		K29-5389-03	KNOB	
A	1B	*	N33-2606-43	OVAL HEAD MACHINE SCREW	
B	1A		N67-3008-48	PAN HEAD SEMS SCREW	
TX-RX UNIT (X57-6100-XX) -10 : K, -11 : K2					
C	3A, 2B		N87-2606-48	BRAZIER HEAD TAPTITE SCREW	
62	2D		N99-2048-05	SCREW SET ACCESSORY	
64	3B	*	T07-0265-15	SPEAKER	
65	1D		T91-0621-35	MICROPHONE ACCESSORY	
101			B11-1148-14	ILLUMINATION GUIDE	
102			B11-1149-04	FILTER	
103			B38-0800-05	LCD	
104		*	E29-1192-04	INTER CONNECTOR	
105		*	J21-8413-04	MOUNTING HARDWARE	
D901			B30-2151-05	LED (RED/GREEN)	
D902-907			B30-2140-05	LED (Y/8)	
D908-911			B30-2050-05	LED	
C1			CK73GB1H103K	CHIP C 0.010UF	K
C3			CC73GCH1H270J	CHIP C 27PF	J
C3			CC73GCH1H470J	CHIP C 47PF	J
C4			CK73GB1H103K	CHIP C 0.010UF	K
C5			CC73GCH1H151J	CHIP C 150PF	J
C6			CK73GB1H103K	CHIP C 0.010UF	K
C7			CK73GB1H102K	CHIP C 1000PF	K
C8			CK73GB1H103K	CHIP C 0.010UF	K
C9			CC73GCH1H101J	CHIP C 100PF	J
C9			CC73GCH1H680J	CHIP C 68PF	J
C10			C93-0563-05	CHIP C 18PF	J
C10			C93-0569-05	CHIP C 56PF	J
C11			CC73GCH1H101J	CHIP C 100PF	J
C11			CK73GB1H103K	CHIP C 0.010UF	K
C12			CC73GCH1H100D	CHIP C 10PF	D
C13			CK73GB1H472K	CHIP C 4700PF	K
C14			CK73GB1H103K	CHIP C 0.010UF	K
C15, 16			CK73GB1H472K	CHIP C 4700PF	K
C17-19			CK73GB1H103K	CHIP C 0.010UF	K
C20			CC73GCH1H470J	CHIP C 47PF	J
C20			CC73GCH1H560J	CHIP C 56PF	J
C21, 22			CC73GCH1H101J	CHIP C 100PF	J
C21, 22			CC73GCH1H121J	CHIP C 120PF	J
C23			CC73GCH1H330J	CHIP C 33PF	J
C23			CC73GCH1H560J	CHIP C 56PF	J
C24			CC73GCH1H390J	CHIP C 39PF	J
C24			CC73GCH1H680J	CHIP C 68PF	J
C25			CK73GB1H103K	CHIP C 0.010UF	K
C28, 29			CK73GB1H103K	CHIP C 0.010UF	K
C30		*	C93-1738-05	CHIP C 270PF	J
C30		*	C93-1744-05	CHIP C 470PF	J
C31		*	CD04AR1E470M	ELECTRO 47UF 25WV	
C32			CK73GB1H103K	CHIP C 0.010UF	K
C33			CK73GB1H472K	CHIP C 4700PF	K
C34			CK73GB1H103K	CHIP C 0.010UF	K
C35			CS77AB21A220M	CHIP TNL 22UF 10WV	
C36			CK73GB1H103K	CHIP C 0.010UF	K
C39, 40			C93-0684-05	CHIP C 6800PF	K

PARTS LIST

TX-RX UNIT (X57-6100-XX)

Ref. No.	Address	New parts	Parts No.	Description	Destination	Ref. No.	Address	New parts	Parts No.	Description	Destination
C41			CC73GCH1H150J	CHIP C 15PF J	K2	C101		*	C90-4139-05	ELECTRO 470UF 25WV	
C42			CC73GCH1H270J	CHIP C 27PF J	K2	C102			CK73GB1H472K	CHIP C 4700PF K	
C45		*	C90-4153-05	ALUMINIUM ELECTROLYTIC C(330UF)		C103			C92-0777-05	ELECTRO 1000UF 25WV	
C46			CK73FB1E104K	CHIP C 0.10UF K		C104		*	CD04AS1H4R7M	ELECTRO 4.7UF 50WV	
C47			CK73GB1H472K	CHIP C 4700PF K		C105, 106			CK73FB1E104K	CHIP C 0.10UF K	
C48			CC73GCH1H101J	CHIP C 100PF J		C107			CK73GB1E105K	CHIP C 1.0UF K	
C49			CK73FB1E104K	CHIP C 0.10UF K		C108		*	CD04AR1E470M	ELECTRO 47UF 25WV	
C50			CK73GB1H103K	CHIP C 0.010UF K		C109, 110			CK73FB1E104K	CHIP C 0.10UF K	
C51			CK73FB1E103K	CHIP C 0.010UF K		C111		*	CD04AR1E101M	ELECTRO 100UF 25WV	
C52			CK73GB1H473K	CHIP C 0.047UF K		C112		*	CD04AR1E470M	ELECTRO 47UF 25WV	
C54			CC73GCH1H020B	CHIP C 2.0PF B		C113			CS77BA0J100M	CHIP TNL 10UF 6.3WV	
C55			CC73GCH1H820J	CHIP C 82PF J		C114, 115			CK73FB1E224K	CHIP C 0.22UF K	
C56			CK73GB1H103K	CHIP C 0.010UF K		C116, 117			CK73GB1H102K	CHIP C 1000PF K	
C58			CK73FB1E104K	CHIP C 0.10UF K		C118, 119			CK73FB1E104K	CHIP C 0.10UF K	
C59-61			CK73GB1H103K	CHIP C 0.010UF K		C120		*	CD04AR1E470M	ELECTRO 47UF 25WV	
C62			CC73GCH1H680J	CHIP C 68PF J		C121			CK73FF1C105Z	CHIP C 1.0UF Z	
C63			CK73GB1H103K	CHIP C 0.010UF K		C122			CK73GB1H471K	CHIP C 470PF K	
C64			CC73GCH1H020B	CHIP C 2.0PF B		C123-126			CK73GB1H103K	CHIP C 0.010UF K	
C65, 66			CC73GCH1H220J	CHIP C 22PF J	K2	C128			CK73FF1C105Z	CHIP C 1.0UF Z	
C65, 66			CC73GCH1H390J	CHIP C 39PF J	K	C129			CK73GB1H471K	CHIP C 470PF K	
C68, 69			CK73GB1C473K	CHIP C 0.047UF K		C130			CS77AB20J470M	CHIP TNL 47UF 6.3WV	
C70			CM73F2H470J	CHIP C 47PF J	K2	C131			CK73GB1H102K	CHIP C 1000PF K	
C70			CM73F2H560J	CHIP C 56PF J	K	C132, 133			CK73GB1H103K	CHIP C 0.010UF K	
C71			CM73F2H120J	CHIP C 12PF J	K	C134			CK73FB1E104K	CHIP C 0.10UF K	
C71			CM73F2H180J	CHIP C 18PF J	K2	C135, 136			CS77BA0J100M	CHIP TNL 10UF 6.3WV	
C72			CM73F2H121J	CHIP C 120PF J		C137, 138			CK73FB1E224K	CHIP C 0.22UF K	
C73			CK73GB1H103K	CHIP C 0.010UF K		C139			CK73GB1C104K	CHIP C 0.10UF K	
C75			CM73F2H240J	CHIP C 24PF J	K2	C140			CK73FB1E224K	CHIP C 0.22UF K	
C75			CM73F2H330J	CHIP C 33PF J	K	C141			CK73GB1C104K	CHIP C 0.10UF K	
C76			CM73F2H470J	CHIP C 47PF J	K2	C142			CK73GB1H471K	CHIP C 470PF K	
C76, 77			CM73F2H470J	CHIP C 47PF J	K	C143			CK73GB1H103K	CHIP C 0.010UF K	K2
C77, 78			CM73F2H560J	CHIP C 56PF J	K2	C144, 145			CK73GB1H102K	CHIP C 1000PF K	
C78			CM73F2H680J	CHIP C 68PF J	K	C200			CK73GB1C104K	CHIP C 0.10UF K	
C79			CM73F2H330J	CHIP C 33PF J	K	C201			CC73GCH1H180J	CHIP C 18PF J	K
C79			CM73F2H390J	CHIP C 39PF J	K2	C203			CC73GCH1H101J	CHIP C 100PF J	
C80			CK73GB1H103K	CHIP C 0.010UF K		C204			CC73GCH1H050C	CHIP C 5.0PF C	K2
C81			CC73GCH1H470J	CHIP C 47PF J	K2	C205			CC73GCH1H390J	CHIP C 39PF J	K
C81			CC73GCH1H560J	CHIP C 56PF J	K	C206			CC73GCH1H470J	CHIP C 47PF J	K2
C82			CC73GCH1H101J	CHIP C 100PF J	K2	C208			CK73GB1C104K	CHIP C 0.10UF K	
C82			CC73GCH1H121J	CHIP C 120PF J	K	C208			CK73GB1H102K	CHIP C 1000PF K	
C83			CC73GCH1H470J	CHIP C 47PF J	K2	C209			CS77BA1A100M	CHIP TNL 10UF 10WV	
C83			CC73GCH1H560J	CHIP C 56PF J	K	C210, 211			CK73GB1H103K	CHIP C 0.010UF K	
C84, 85			CC73GCH1H220J	CHIP C 22PF J	K2	C212			CK73GB1C104K	CHIP C 0.10UF K	
C84, 85			CC73GCH1H390J	CHIP C 39PF J	K	C213			CC73GCH1H050C	CHIP C 5.0PF C	K2
C86			CC73GCH1H270J	CHIP C 27PF J	K2	C214			CK73GB1H103K	CHIP C 0.010UF K	
C86			CC73GCH1H560J	CHIP C 56PF J	K	C216			CC73GCH1H120J	CHIP C 12PF J	K
C87, 88			CC73GCH1H220J	CHIP C 22PF J	K2	C216			CC73GCH1H180J	CHIP C 18PF J	K2
C87, 88			CC73GCH1H390J	CHIP C 39PF J	K	C217			CK73GB1C104K	CHIP C 0.10UF K	
C89			CC73GCH1H470J	CHIP C 47PF J	K2	C218			CK73GB1H103K	CHIP C 0.010UF K	
C89			CC73GCH1H560J	CHIP C 56PF J	K	C219			CK73GB1C104K	CHIP C 0.10UF K	
C90			CC73GCH1H101J	CHIP C 100PF J	K2	C221			CC73GCH1H050C	CHIP C 5.0PF C	K2
C90			CC73GCH1H121J	CHIP C 120PF J	K	C222			CC73GCH1H101J	CHIP C 100PF J	
C91			CC73GCH1H470J	CHIP C 47PF J	K2	C224			CK73GB1C104K	CHIP C 0.10UF K	
C91			CC73GCH1H560J	CHIP C 56PF J	K	C225			CC73GCH1H270J	CHIP C 27PF J	
C92-96			CK73GB1H103K	CHIP C 0.010UF K		C226			CK73GB1H102K	CHIP C 1000PF K	
C99		*	C93-1736-05	CHIP C 680PF J	K	C227			CC73GCH1H100D	CHIP C 10PF D	
C99		*	C93-1744-05	CHIP C 470PF J	K2	C228			CC73GCH1H180J	CHIP C 18PF J	
						C229			CC73GCH1H040C	CHIP C 4.0PF C	
						C230			CC73GCH1H680J	CHIP C 68PF J	
						C231, 232			CK73GB1H103K	CHIP C 0.010UF K	

PARTS LIST

TX-RX UNIT (X57-6100-XX)

Ref. No.	Address	New parts	Parts No.	Description	Desti-nation	Ref. No.	Address	New parts	Parts No.	Description	Desti-nation
C233			CK73GB1H471K	CHIP C 470PF K		C400			CK73GB1H103K	CHIP C 0.010UF K	
C235			CK73GB1H471K	CHIP C 470PF K		C401			CK73GB1H104K	CHIP C 0.10UF K	
C236-238			CK73GB1H102K	CHIP C 1000PF K		C402			CS77AA1C4R7M	CHIP TNL 4.7UF 16WV	
C239			CC73GCH1H030C	CHIP C 3.0PF C		C403			CC73GCH1H680J	CHIP C 68PF J	
C240			CC73GCH1H180J	CHIP C 18PF J		C405, 406			CK73GB1H103K	CHIP C 0.010UF K	
C241			CK73GB1H102K	CHIP C 1000PF K		C407			CC73GCH1H120J	CHIP C 12PF J	K2
C242			CK73GB1C473K	CHIP C 0.047UF K		C407			CC73GCH1H390J	CHIP C 39PF J	K
C243			CK73GB1H102K	CHIP C 1000PF K		C408			CK73GB1H103K	CHIP C 0.010UF K	
C245			CC73GCH1H1R5B	CHIP C 1.5PF B		C409			CC73GCH1H471J	CHIP C 470PF J	
C246			CK73GB1H102K	CHIP C 1000PF K		C410			CK73GB1H103K	CHIP C 0.010UF K	
C247, 248			CK73GB1H103K	CHIP C 0.010UF K		C412-414			CK73GB1H103K	CHIP C 0.010UF K	
C249			CC73GCH1H020B	CHIP C 2.0PF B		C415			CK73GB1H102K	CHIP C 1000PF K	
C250			CC73GCH1H2R5B	CHIP C 2.5PF B		C416			CK73GB1E105K	CHIP C 1.0UF K	
C251			CC73GCH1HOR5B	CHIP C 0.5PF B		C417			CK73GB1H103K	CHIP C 0.010UF K	
C252			CK73GB1H102K	CHIP C 1000PF K		C418			CK73GB1H102K	CHIP C 1000PF K	
C253			CK73GB1H103K	CHIP C 0.010UF K		C419	*		CS77AA1A3R3M	CHIP TNL 3.3UF 10WV	
C255			CK73GB1H102K	CHIP C 1000PF K		C420			CK73GB1H102K	CHIP C 1000PF K	
C256			CK73GB1C104K	CHIP C 0.10UF K		C421			CC73GCH1H221J	CHIP C 220PF J	
C257-259			CK73GB1H102K	CHIP C 1000PF K		C422			CC73GCH1H680J	CHIP C 68PF J	
C260			CC73GCH1H030C	CHIP C 3.0PF C		C423-425			CK73GB1H103K	CHIP C 0.010UF K	
C262			CK73GB1C104K	CHIP C 0.10UF K		C426			CK73GB1H222K	CHIP C 2200PF K	
C263			CK73GB1H102K	CHIP C 1000PF K		C430			CC73GCH1H221J	CHIP C 220PF J	
C264			CS77CA1C010M	CHIP TNL 1.0UF 16WV		C501			CS77BA0J100M	CHIP TNL 10UF 6.3WV	
C266			CC73GCH1H270J	CHIP C 27PF J		C502			CC73GCH1H100D	CHIP C 10PF D	
C267, 268			CK73GB1C104K	CHIP C 0.10UF K		C503			CK73GB1H103K	CHIP C 0.010UF K	
C269, 270			CK73GB1H102K	CHIP C 1000PF K		C504, 505			CK73GB1H102K	CHIP C 1000PF K	
C271			CK73GB1H103K	CHIP C 0.010UF K		C507			CS77BA0J100M	CHIP TNL 10UF 6.3WV	
C272			CK73GB1H102K	CHIP C 1000PF K		C510			CS77AB20J470M	CHIP TNL 47UF 6.3WV	
C273			CK73GB1C104K	CHIP C 0.10UF K		C511, 512			CK73GB1H103K	CHIP C 0.010UF K	
C274			CK73GB1H681K	CHIP C 680PF K		C513			CC73GCH1H100D	CHIP C 10PF D	
C275, 276			CK73GB1H102K	CHIP C 1000PF K		C514			CK73GB1H102K	CHIP C 1000PF K	
C277			CK73FB1H223K	CHIP C 0.022UF K		C516			CC73GCH1H100D	CHIP C 10PF D	
C278			CS77BA0J100M	CHIP TNL 10UF 6.3WV		C517, 518			CK73GB1H102K	CHIP C 1000PF K	
C279			CK73FB1C334K	CHIP C 0.33UF K		C519			CK73GB1H103K	CHIP C 0.010UF K	
C280			CK73GB1H103K	CHIP C 0.010UF K		C521			CK73GB1H103K	CHIP C 0.010UF K	
C281			CS77BA0J100M	CHIP TNL 10UF 6.3WV		C522			CS77BA0J4R7M	CHIP TNL 4.7UF 6.3WV	
C282			CK73GB1H103K	CHIP C 0.010UF K		C523, 524			CK73GB1H102K	CHIP C 1000PF K	
C283			CC73GCH1H330J	CHIP C 33PF J	K2	C525			CK73GB1H222K	CHIP C 2200PF K	
C283			CC73GCH1H390J	CHIP C 39PF J	K	C526			CC73GCH1H101J	CHIP C 100PF J	
C285, 286			CC73GCH1H150J	CHIP C 15PF J		C527			CS77BA0J4R7M	CHIP TNL 4.7UF 6.3WV	
C287			CC73GCH1H020B	CHIP C 2.0PF B		C528			CC73GCH1H120J	CHIP C 12PF J	
C288			CC73GCH1H150J	CHIP C 15PF J		C529			CC73GCH1H151J	CHIP C 150PF J	K2
C290			CC73GCH1H020B	CHIP C 2.0PF B		C529			CC73GCH1H470J	CHIP C 47PF J	K
C291			CC73GCH1H101J	CHIP C 100PF J		C530			CK73GB1H102K	CHIP C 1000PF K	
C293			CC73GCH1H020B	CHIP C 2.0PF B		C531-533			CC73GCH1H101J	CHIP C 100PF J	
C294			CC73GCH1H150J	CHIP C 15PF J		C534, 535			CK73GB1H102K	CHIP C 1000PF K	
C296			CC73GCH1H020B	CHIP C 2.0PF B		C536			CC73GCH1H101J	CHIP C 100PF J	
C297			CC73GCH1H180J	CHIP C 18PF J		C537			CK73GB1H102K	CHIP C 1000PF K	
C299			CC73GCH1H2R5B	CHIP C 2.5PF B		C538			CC73GCH1H180J	CHIP C 18PF J	
C300			CC73GCH1H270J	CHIP C 27PF J		C539			CK73GB1H103K	CHIP C 0.010UF K	
C301, 302			CC73GCH1H2R5B	CHIP C 2.5PF B		C540			CK73GB1H102K	CHIP C 1000PF K	
C303			CC73GCH1H220J	CHIP C 22PF J		C541			CC73GCH1H101J	CHIP C 100PF J	
C304, 305			CC73GCH1H2R5B	CHIP C 2.5PF B		C542			CS77CA1V0R1M	CHIP TNL 0.1UF 35WV	
C306			CC73GCH1H330J	CHIP C 33PF J		C543			CS77BA0J100M	CHIP TNL 10UF 6.3WV	
C307, 308			CK73GB1H102K	CHIP C 1000PF K		C544			CS77CA1C010M	CHIP TNL 1.0UF 16WV	
C309			CC73GCH1H010B	CHIP C 1.0PF B		C545, 546			CS77AB20J470M	CHIP TNL 47UF 6.3WV	
C310-312			CK73GB1H102K	CHIP C 1000PF K		C547			CK73GB1C473K	CHIP C 0.047UF K	
						C548			CK73GB1H102K	CHIP C 1000PF K	K2
						C548, 549			CK73GB1H102K	CHIP C 1000PF K	K
						C549			CC73GCH1H101J	CHIP C 100PF J	K2

PARTS LIST

TX-RX UNIT (X57-6100-XX)

Ref. No.	Address	New parts	Parts No.	Description	Destination	Ref. No.	Address	New parts	Parts No.	Description	Destination
C550			CC73GCH1H060B	CHIP C 6.0PF B	K2	C716			CK73GB1H471K	CHIP C 470PF K	
C550			CC73GCH1H080B	CHIP C 8.0PF B	K	C720			CK73GB1H103K	CHIP C 0.010UF K	
C551			CS77CA1C010M	CHIP TNTL 1.0UF 16WV		C723			CK73GB1H103K	CHIP C 0.010UF K	
C552			CK73GB1H103K	CHIP C 0.010UF K		C725, 726			CC73GCH1H101J	CHIP C 100PF J	
C553			CS77BA0J100M	CHIP TNTL 10UF 6.3WV		C728			CK73GB1H471K	CHIP C 470PF K	
C554			CK73GB1H102K	CHIP C 1000PF K		C730, 731			CC73GCH1H101J	CHIP C 100PF J	
C555			CC73GCH1H060D	CHIP C 6.0PF D K		C733			CK73GB1C104K	CHIP C 0.10UF K	
C557			CK73GB1H102K	CHIP C 1000PF K		C734, 735			CC73GCH1H101J	CHIP C 100PF J	
C559			CC73GCH1H220J	CHIP C 22PF J		C737			CK73GB1C104K	CHIP C 0.10UF K	
C560, 561			CK73GB1H102K	CHIP C 1000PF K		C738, 739			CC73GCH1H101J	CHIP C 100PF J	
C564			CC73GCH1H180J	CHIP C 18PF J		C741, 742			CC73GCH1H101J	CHIP C 100PF J	
C565			CC73GCH1H470J	CHIP C 47PF J		C744, 745			CC73GCH1H101J	CHIP C 100PF J	
C568			CK73GB1H102K	CHIP C 1000PF K		C747, 748			CC73GCH1H101J	CHIP C 100PF J	
C569			CC73GCH1H390J	CHIP C 39PF J		C750, 751			CC73GCH1H101J	CHIP C 100PF J	
C570			CC73GCH1H220J	CHIP C 22PF J		C753, 754			CC73GCH1H101J	CHIP C 100PF J	
C571			CK73GB1H102K	CHIP C 1000PF K		C756			CC73GCH1H101J	CHIP C 100PF J	
C573			CC73GCH1H050C	CHIP C 5.0PF C		C757			CK73GB1H102K	CHIP C 1000PF K	
C574			CC73GCH1H180J	CHIP C 18PF J		C759			CC73GCH1H101J	CHIP C 100PF J	
C575, 576			CK73GB1H102K	CHIP C 1000PF K		C760			CS77BA0J100M	CHIP TNTL 10UF 6.3WV	
C577			CC73GCH1H270J	CHIP C 27PF J		C764-767			CK73GB1H102K	CHIP C 1000PF K	
C578			CC73GCH1H150J	CHIP C 15PF J		C768			CK73GB1C333K	CHIP C 0.033UF K	
C579			CC73GCH1H070D	CHIP C 7.0PF D		C770			CC73GCH1H121J	CHIP C 120PF J	
C580			CC73GCH1H060D	CHIP C 6.0PF D	K	C771			CK73GB1H103K	CHIP C 0.010UF K	
C581			CC73GCH1H040C	CHIP C 4.0PF C		C772			CK73GB1C273K	CHIP C 0.027UF K	
C582			CK73GB1H102K	CHIP C 1000PF K		C773			CK73GB1H103K	CHIP C 0.010UF K	
C583			CC73GCH1H270J	CHIP C 27PF J	K	C774			CK73GB1H222K	CHIP C 2200PF K	
C584			CC73GCH1H150J	CHIP C 15PF J		C775			CC73GCH1H271J	CHIP C 270PF J	
C585			CK73GB1H102K	CHIP C 1000PF K		C776			CK73GB1H103K	CHIP C 0.010UF K	
C586			CC73GCH1H100D	CHIP C 10PF D		C777			CK73GB1H472K	CHIP C 4700PF K	
C587			CC73GCH1H090D	CHIP C 9.0PF D		C778			CK73GB1E123K	CHIP C 0.012UF K	
C588-594			CK73GB1H102K	CHIP C 1000PF K	K	C779			CK73GB1C683K	CHIP C 0.068UF K	
C588, 589			CK73GB1H102K	CHIP C 1000PF K	K2	C780			CK73GB1H103K	CHIP C 0.010UF K	
C590			CC73GCH1H820J	CHIP C 82PF J	K2	C781			CC73GCH1H101J	CHIP C 100PF J	
C591-594			CK73GB1H102K	CHIP C 1000PF K	K2	C782			CS77CA1ER47M	CHIP TNTL 0.47UF 25WV	
C595			CC73GCH1H220J	CHIP C 22PF J		C783			CK73GB1H103K	CHIP C 0.010UF K	
C596			CK73GB1H103K	CHIP C 0.010UF K		C784			CK73GB1C473K	CHIP C 0.047UF K	
C597			CK73GB1H102K	CHIP C 1000PF K		C785			CK73GB1C104K	CHIP C 0.10UF K	
C598			CK73GB1H103K	CHIP C 0.010UF K		C786-788			CK73GB1H103K	CHIP C 0.010UF K	
C599			CC73GCH1H470J	CHIP C 47PF J		C789			CS77BA0J4R7M	CHIP TNTL 4.7UF 6.3WV	
C601			CK73GB1H102K	CHIP C 1000PF K		C791			CK73GB1C104K	CHIP C 0.10UF K	
C602			CK73FF1C105Z	CHIP C 1.0UF Z		C792, 793			CK73GB1H103K	CHIP C 0.010UF K	
C603			CK73GB1H471K	CHIP C 470PF K		C794			CS77BA0J100M	CHIP TNTL 10UF 6.3WV	
C604			CK73GB1H103K	CHIP C 0.010UF K		C795			CK73GB1C104K	CHIP C 0.10UF K	
C605			CK73GB1H222K	CHIP C 2200PF K		C796			CC73GCH1H471J	CHIP C 470PF J	
C606			CK73FF1C105Z	CHIP C 1.0UF Z		C797			CK73GB1H103K	CHIP C 0.010UF K	
C607			CK73GB1H222K	CHIP C 2200PF K		C798			CK73GB1H102K	CHIP C 1000PF K	
C608			CK73GB1H471K	CHIP C 470PF K		C800			CK73GB1H103K	CHIP C 0.010UF K	
C609			CS77AB20J470M	CHIP TNTL 47UF 6.3WV		C801			CK73GB1H122J	CHIP C 1200PF J	
C610			CK73GB1H102K	CHIP C 1000PF K		C802			CK73GB1C104K	CHIP C 0.10UF K	
C611-639			CC73HCH1H101J	CHIP C 100PF J		C803-805			CK73GB1H103K	CHIP C 0.010UF K	
C640			CK73GB1H102K	CHIP C 1000PF K		C806, 807			CK73GB1C104K	CHIP C 0.10UF K	
C641			CS77BA0J100M	CHIP TNTL 10UF 6.3WV		C808			CK73GB1H103K	CHIP C 0.010UF K	
C642			CK73GB1H102K	CHIP C 1000PF K		C809			CK73GB1C104K	CHIP C 0.10UF K	
C643			CK73GB1C104K	CHIP C 0.10UF K		C810-812			CK73GB1H562J	CHIP C 5600PF J	
C703			CK73GB1C104K	CHIP C 0.10UF K		C813			CK73GB1H272J	CHIP C 2700PF J	
C704			CS77BA0J100M	CHIP TNTL 10UF 6.3WV		C814			CC73GCH1H470J	CHIP C 47PF J	
C706			CK73GB1H332K	CHIP C 3300PF K		C815			CK73GB1C333K	CHIP C 0.033UF K	
C707			CC73GCH1H151J	CHIP C 150PF J		C816, 817			CK73GB1H272J	CHIP C 2700PF J	
C711			CK73GB1C104K	CHIP C 0.10UF K		C818			CC73GCH1H090D	CHIP C 9.0PF D	
C715			CK73GB1C104K	CHIP C 0.10UF K		C819			CS77BA0J100M	CHIP TNTL 10UF 6.3WV	

PARTS LIST

TX-RX UNIT (X57-6100-XX)

Ref. No.	Address	New parts	Parts No.	Description	Desti-nation	Ref. No.	Address	New parts	Parts No.	Description	Desti-nation
C820			CC73GCH1H151J	CHIP C 150PF J		L1			L41-4705-33	SMALL FIXED INDUCTOR (47UH)	
C821			CC73GCH1H090D	CHIP C 9.0PF D		L2			L41-2785-33	SMALL FIXED INDUCTOR (0.27UH)	K2
C822			CK73GB1H122J	CHIP C 1200PF J		L2	*		L41-3385-33	SMALL FIXED INDUCTOR (0.33UH)	K
C823			CK73GB1H102K	CHIP C 1000PF K		L3, 4			L92-0148-05	CHIP FERRITE	
C824			CS77BA0J100M	CHIP TNTL 10UF 6.3WV		L5			L41-1095-32	SMALL FIXED INDUCTOR (1UH) K	
C825			CK73GB1C104K	CHIP C 0.10UF K		L5	*		L41-2285-32	SMALL FIXED INDUCTOR (0.22UH)	K2
C826			CC73GCH1H101J	CHIP C 100PF J		L6-8			L41-1585-33	SMALL FIXED INDUCTOR (0.15UH)	
C827-830			CK73GB1C104K	CHIP C 0.10UF K		L9			L39-1439-05	TOROIDAL COIL	
C831			CK73GB1H103K	CHIP C 0.010UF K		L10			L33-0666-05	CHOKE COIL	
C832			CS77BA0J100M	CHIP TNTL 10UF 6.3WV		L11	*		L39-1433-15	TOROIDAL COIL	
C833			CK73GB1H472K	CHIP C 4700PF K		L12			L33-0625-15	TOROIDAL COIL	
C834			CK73GB1H103K	CHIP C 0.010UF K		L13	*		L39-1432-15	TOROIDAL COIL K	
C836			CK73GB1H472K	CHIP C 4700PF K		L13	*		L39-1523-15	TOROIDAL COIL K2	
C837			CS77BA0J4R7M	CHIP TNTL 4.7UF 6.3WV		L14			L41-2205-33	SMALL FIXED INDUCTOR (22UH)	
C838			CK73GB1E153K	CHIP C 0.015UF K		L15			L39-1420-25	TOROIDAL COIL	
C839			CC73GCH1H101J	CHIP C 100PF J		L16			L41-2205-33	SMALL FIXED INDUCTOR (22UH)	
C840			CK73FB1H563K	CHIP C 0.056UF K		L18	*		L34-4895-05	AIR-CORE COIL K	
C841			CS77BA0J4R7M	CHIP TNTL 4.7UF 6.3WV		L18, 19	*		L34-4883-05	AIR-CORE COIL K2	
C843			CK73GB1H102K	CHIP C 1000PF K		L19	*		L34-4884-05	AIR-CORE COIL K	
C844			CK73GB1H272K	CHIP C 2700PF K		L20	*		L34-4885-05	AIR-CORE COIL K2	
C845			CK73GB1C104K	CHIP C 0.10UF K		L20	*		L34-4889-05	AIR-CORE COIL K	
C891			C93-0595-05	CHIP C 220PF K	K2	L21			L41-4785-33	SMALL FIXED INDUCTOR (0.47UH)	
C891-894			C93-0596-05	CHIP C 270PF K	K	L22, 23			L40-1585-92	SMALL FIXED INDUCTOR (150NH)	
C892, 893			C93-0596-05	CHIP C 270PF K	K2	L24, 25			L41-1585-33	SMALL FIXED INDUCTOR (0.15UH)	
C894			C93-0595-05	CHIP C 220PF K	K2	L26			L40-6875-92	SMALL FIXED INDUCTOR (68NH)	K2
C895			C93-0573-05	CHIP C 120PF J	K	L201			L41-8275-33	SMALL FIXED INDUCTOR (0.082UH)	K
C898			C93-0573-05	CHIP C 120PF J	K	L202, 203	*		L34-4860-05	COIL K2	
C902, 903			CK73GB1H102K	CHIP C 1000PF K		L202, 203	*		L34-4862-05	COIL K	
C906			CK73GB1H102K	CHIP C 1000PF K		L204			L40-1275-92	SMALL FIXED INDUCTOR (12NH)	
C907			CS77CA1C010M	CHIP TNTL 1.0UF 16WV		L205			L41-1005-33	SMALL FIXED INDUCTOR (10UH)	
C908			CC73GCH1H101J	CHIP C 100PF J		L206, 207	*		L34-4860-05	COIL K2	
TC202			C05-0384-05	CERAMIC TRIMMER CAPACITOR (10PF)		L206, 207	*		L34-4862-05	COIL K	
TC204			C05-0384-05	CERAMIC TRIMMER CAPACITOR (10PF)		L208			L40-6875-92	SMALL FIXED INDUCTOR (68NH)	
CN1			E40-6053-05	FLAT CABLE CONNECTOR		L209, 210			L40-8275-92	SMALL FIXED INDUCTOR (82NH)	
CN2			E41-2834-05	PIN ASSY		L211			L40-1285-92	SMALL FIXED INDUCTOR (120NH)	
CN3			E40-6050-05	FLAT CABLE CONNECTOR		L212			L40-2285-92	SMALL FIXED INDUCTOR (220NH)	K2
CN4			E40-6530-05	PIN ASSY		L212			L40-2785-92	SMALL FIXED INDUCTOR (270NH)	K
CN5			E41-1682-05	PIN ASSY		L213, 214			L39-1498-05	TOROIDAL COIL	
CN201-204			E41-2735-05	PIN ASSY		L215			L92-0138-05	CHIP FERRITE	
CN902			E40-6050-05	FLAT CABLE CONNECTOR		L216			L39-1498-05	TOROIDAL COIL	
CN904			E40-6053-05	FLAT CABLE CONNECTOR		L217			L40-1885-92	SMALL FIXED INDUCTOR (180NH)	
J901			E58-0522-05	MODULAR JACK		L218			L41-1295-33	SMALL FIXED INDUCTOR (1.2UH)	
W1	*		E37-0900-05	PROCESSED LEAD WIRE		L219			L34-4616-05	AIR-CORE COIL	
W2			E30-3340-05	DC CORD		L220			L41-1295-33	SMALL FIXED INDUCTOR (1.2UH)	
A1	*		F10-2326-13	SHIELDING PLATE		L221			L41-2205-33	SMALL FIXED INDUCTOR (22UH)	
A2			F10-2380-04	SHIELDING PLATE		L222, 223	*		L34-4861-05	COIL	
A6	*		F10-2386-04	SHIELDING PLATE		L224	*		L34-4863-05	COIL	
F1			F53-0392-05	FUSE (3A/32V)		L225	*		L34-4861-05	COIL	
F701			F53-0108-05	FUSE (1.8A/50V)		L226, 227			L40-1885-92	SMALL FIXED INDUCTOR (180NH)	
A5			G13-1772-14	CUSHION		L228			L40-1585-92	SMALL FIXED INDUCTOR (150NH)	
A4	*		J42-0702-05	BUSHING		L229-236			L34-4520-05	AIR-CORE COIL	
A905			J31-0543-05	COLLAR (LH-5-1.5)		L237			L34-4725-05	COIL	
GF201, 202			L72-0916-05	CERAMIC FILTER		L401			L41-1095-33	SMALL FIXED INDUCTOR (1.0UH)	
						L403			L41-1095-33	SMALL FIXED INDUCTOR (1.0UH)	
						L501, 502			L92-0138-05	CHIP FERRITE	
						L503			L41-4795-33	SMALL FIXED INDUCTOR (4.7UH)	

PARTS LIST

TX-RX UNIT (X57-6100-XX)

Ref. No.	Address	New parts	Parts No.	Description	Destination	Ref. No.	Address	New parts	Parts No.	Description	Destination
L504-510			L92-0138-05	CHIP FERRITE		R23 , 24			RS14DB3F101J	FL-PROOF RS 100 J 3W	
L511			L40-1285-92	SMALL FIXED INDUCTOR (120NH)		R25			RK73GB2A104J	CHIP R 100K J 1/10W	
L512			L41-2285-43	SMALL FIXED INDUCTOR (220NH)		R26			RK73GB2A123J	CHIP R 12K J 1/10W	
L513			L92-0138-05	CHIP FERRITE		R27			RK73GB2A105J	CHIP R 1.0M J 1/10W	
L514			L40-4775-92	SMALL FIXED INDUCTOR (47NH)	K2	R28			RK73GB2A330J	CHIP R 33 J 1/10W	
L514			L40-5675-92	SMALL FIXED INDUCTOR (56NH)	K	R29			RK73GB2A103J	CHIP R 10K J 1/10W	
L515			L92-0138-05	CHIP FERRITE		R30 , 31			RK73GB2A270J	CHIP R 27 J 1/10W	
L516			L40-2285-92	SMALL FIXED INDUCTOR (220NH)	K	R32			RK73GB2A220J	CHIP R 22 J 1/10W	
L517		*	L78-1432-05	VCO		R33			RK73GB2A183J	CHIP R 18K J 1/10W	
L518			L40-2285-92	SMALL FIXED INDUCTOR (220NH)	K	R35			RK73GB2A223J	CHIP R 22K J 1/10W	
L519-522			L92-0138-05	CHIP FERRITE		R36			RK73GB2A473J	CHIP R 47K J 1/10W	
L523			L40-5675-92	SMALL FIXED INDUCTOR (56NH)		R37			RK73GB2A000J	CHIP R 0.0 J 1/10W	K
L524			L40-4775-92	SMALL FIXED INDUCTOR (47NH)		R38			RK73GB2A471J	CHIP R 470 J 1/10W	
L525			L40-5675-92	SMALL FIXED INDUCTOR (56NH)		R39			RK73GB2A102J	CHIP R 1.0K J 1/10W	
L526			L40-4775-92	SMALL FIXED INDUCTOR (47NH)		R41			RK73GB2A331J	CHIP R 330 J 1/10W	K2
L527			L40-1285-92	SMALL FIXED INDUCTOR (120NH)		R42			RK73GB2A000J	CHIP R 0.0 J 1/10W	
L528			L40-4775-92	SMALL FIXED INDUCTOR (47NH)		R44 , 45			RK73GB2A000J	CHIP R 0.0 J 1/10W	
L529			L40-3975-92	SMALL FIXED INDUCTOR (39NH)		R46			RK73GB2A153J	CHIP R 15K J 1/10W	
L530			L40-8275-92	SMALL FIXED INDUCTOR (82NH)		R47			RK73GB2A000J	CHIP R 0.0 J 1/10W	
L531, 532			L40-1085-92	SMALL FIXED INDUCTOR (100NH)		R48			RK73GB2A103J	CHIP R 10K J 1/10W	
L533			L40-1285-92	SMALL FIXED INDUCTOR (120NH)		R49			RK73GB2A472J	CHIP R 4.7K J 1/10W	
L534			L40-3375-92	SMALL FIXED INDUCTOR (33NH)		R50			RK73GB2A104J	CHIP R 100K J 1/10W	
L535			L40-8275-92	SMALL FIXED INDUCTOR (82NH)		R52			RK73GB2A000J	CHIP R 0.0 J 1/10W	K
L536			L40-3375-92	SMALL FIXED INDUCTOR (33NH)		R52			RK73GB2A121J	CHIP R 120 J 1/10W	K2
L537			L40-1085-92	SMALL FIXED INDUCTOR (100NH)		R53			RK73GB2A681J	CHIP R 680 J 1/10W	
L538			L40-1585-92	SMALL FIXED INDUCTOR (150NH)		R54			RK73GB2A391J	CHIP R 390 J 1/10W	
L540			L40-2785-92	SMALL FIXED INDUCTOR (270NH)	K2	R55			RK73GB2A104J	CHIP R 100K J 1/10W	
L541			L40-1075-92	SMALL FIXED INDUCTOR (10NH)	K	R56 -59			RK73GB2A562J	CHIP R 5.6K J 1/10W	
L602			L92-0138-05	CHIP FERRITE		R60			RK73GB2A153J	CHIP R 15K J 1/10W	
L604			L41-1005-33	SMALL FIXED INDUCTOR (10UH)		R61			RK73GB2A103J	CHIP R 10K J 1/10W	
L701-703			L92-0138-05	CHIP FERRITE		R62			RK73GB2A473J	CHIP R 47K J 1/10W	
L704-706			L92-0140-05	CHIP FERRITE		R63			RK73GB2A152J	CHIP R 1.5K J 1/10W	
L901			L92-0138-05	CHIP FERRITE		R65 -68		*	RK73EB2E1R0J	CHIP R 1.0 J 1/4W	
X501			L77-3026-05	VCXO (16.8MHZ)		R71 , 72			RK73FB2B000J	CHIP R 0.0 J 1/8W	
X701			L77-1708-15	CRYSTAL RESONATOR (3.579545MHZ)		R73			RK73GB2A330J	CHIP R 33 J 1/10W	K2
XF201			L71-0560-05	MCF (128.55MHZ)		R74			RK73GB2A561J	CHIP R 560 J 1/10W	
CP601-609			R90-0741-05	MULTIPLE RESISTOR		R101			RS14DB3D2R2J	FL-PROOF RS 2.2 J 2W	
CP610-624			R90-0740-05	MULTIPLE RESISTOR		R102			RK73GB2A102J	CHIP R 1.0K J 1/10W	
CP625			R90-0743-05	MULTIPLE RESISTOR		R103			RK73GB2A104J	CHIP R 100K J 1/10W	
CP626, 627			R90-0741-05	MULTIPLE RESISTOR		R104			RK73GB2A473J	CHIP R 47K J 1/10W	
R1			RK73GB2A333J	CHIP R 33K J 1/10W	K2	R105			RK73GB2A104J	CHIP R 100K J 1/10W	
R1			RK73GB2A473J	CHIP R 47K J 1/10W	K	R106			RK73GB2A000J	CHIP R 0.0 J 1/10W	
R2			RK73GB2A471J	CHIP R 470 J 1/10W		R107			RK73GB2A473J	CHIP R 47K J 1/10W	
R3			RK73GB2A100J	CHIP R 10 J 1/10W		R108			RK73GB2A333J	CHIP R 33K J 1/10W	
R4			RK73GB2A122J	CHIP R 1.2K J 1/10W		R109			RK73GB2A103J	CHIP R 10K J 1/10W	
R5			RK73GB2A220J	CHIP R 22 J 1/10W		R110			RK73FB2B000J	CHIP R 0.0 J 1/8W	
R6			RK73GB2A181J	CHIP R 180 J 1/10W		R111			RK73GB2A103J	CHIP R 10K J 1/10W	
R7			RK73GB2A331J	CHIP R 330 J 1/10W	K	R112			RK73GB2A471J	CHIP R 470 J 1/10W	
R8			RK73GB2A100J	CHIP R 10 J 1/10W	K2	R113			RK73GB2A104J	CHIP R 100K J 1/10W	
R8			RK73GB2A180J	CHIP R 18 J 1/10W	K	R114			RK73GB2A333J	CHIP R 33K J 1/10W	
R9			RK73GB2A331J	CHIP R 330 J 1/10W	K	R115-117			RK73GB2A473J	CHIP R 47K J 1/10W	
R10			RK73GB2A560J	CHIP R 56 J 1/10W		R118			RK73GB2A472J	CHIP R 4.7K J 1/10W	
R11			RK73GB2A123J	CHIP R 12K J 1/10W	K2	R119-121			RK73GB2A473J	CHIP R 47K J 1/10W	
R11			RK73GB2A183J	CHIP R 18K J 1/10W	K	R123			RK73GB2A152J	CHIP R 1.5K J 1/10W	
R12			RK73GB2A683J	CHIP R 68K J 1/10W		R124, 125			RK73GB2A472J	CHIP R 4.7K J 1/10W	
R13			RK73GB2A223J	CHIP R 22K J 1/10W		R127			RK73GB2A333J	CHIP R 33K J 1/10W	
R14			RK73GB2A472J	CHIP R 4.7K J 1/10W		R128			RK73GB2A474J	CHIP R 470K J 1/10W	
R15 -18			RK73FB2B101J	CHIP R 100 J 1/8W		R129-132			RK73GB2A103J	CHIP R 10K J 1/10W	
R19 -22			R92-1264-05	CHIP R 5.6 J 1W		R133			RK73GB2A100J	CHIP R 10 J 1/10W	
						R134			RK73GB2A473J	CHIP R 47K J 1/10W	

PARTS LIST

TX-RX UNIT (X57-6100-XX)

Ref. No.	Address	New parts	Parts No.	Description	Destination	Ref. No.	Address	New parts	Parts No.	Description	Destination
R135			RK73GB2A103J	CHIP R 10K J 1/10W		R401			RK73GB2A104J	CHIP R 100K J 1/10W	
R136			RK73GB2A394J	CHIP R 390K J 1/10W		R402			RK73GB2A103J	CHIP R 10K J 1/10W	
R137			RK73GB2A104J	CHIP R 100K J 1/10W		R403			RK73GB2A000J	CHIP R 0.0 J 1/10W	
R138, 139			RK73GB2A394J	CHIP R 390K J 1/10W		R404			RK73GB2A274J	CHIP R 270K J 1/10W	K2
R140, 141			RK73GB2A104J	CHIP R 100K J 1/10W		R404			RK73GB2A334J	CHIP R 330K J 1/10W	K
R142			RK73GB2A473J	CHIP R 47K J 1/10W		R405			RK73GB2A104J	CHIP R 100K J 1/10W	
R143, 144			RK73GB2A103J	CHIP R 10K J 1/10W		R406			RK73GB2A333J	CHIP R 33K J 1/10W	
R145			RK73GB2A102J	CHIP R 1.0K J 1/10W		R407			RK73GB2A101J	CHIP R 100 J 1/10W	
R147			RK73GB2A221J	CHIP R 220 J 1/10W		R408			RK73GB2A681J	CHIP R 680 J 1/10W	
R201			RK73GB2A473J	CHIP R 47K J 1/10W		R409			RK73GB2A151J	CHIP R 150 J 1/10W	
R202, 203			RK73GB2A103J	CHIP R 10K J 1/10W		R410			RK73GB2A330J	CHIP R 33 J 1/10W	
R204			RK73GB2A393J	CHIP R 39K J 1/10W		R411			RK73GB2A103J	CHIP R 10K J 1/10W	
R205			RK73GB2A102J	CHIP R 1.0K J 1/10W		R412			RK73GB2A123J	CHIP R 12K J 1/10W	
R206-208			RK73GB2A103J	CHIP R 10K J 1/10W		R413			RK73GB2A103J	CHIP R 10K J 1/10W	
R211			RK73GB2A560J	CHIP R 56 J 1/10W		R414			RK73GB2A562J	CHIP R 5.6K J 1/10W	
R212			RK73GB2A330J	CHIP R 33 J 1/10W		R415			RK73GB2A101J	CHIP R 100 J 1/10W	
R215			RK73GB2A000J	CHIP R 0.0 J 1/10W		R416, 417			RK73GB2A103J	CHIP R 10K J 1/10W	
R216			RK73GB2A103J	CHIP R 10K J 1/10W		R418			RK73GB2A000J	CHIP R 0.0 J 1/10W	
R218			RK73GB2A000J	CHIP R 0.0 J 1/10W		R419, 420			RK73GB2A272J	CHIP R 2.7K J 1/10W	
R221			RK73GB2A000J	CHIP R 0.0 J 1/10W		R421			RK73GB2A333J	CHIP R 33K J 1/10W	
R223			RK73GB2A000J	CHIP R 0.0 J 1/10W		R422			RK73GB2A684J	CHIP R 680K J 1/10W	
R225			RK73GB2A000J	CHIP R 0.0 J 1/10W		R423			RK73GB2A104J	CHIP R 100K J 1/10W	
R226			RK73GB2A151J	CHIP R 150 J 1/10W		R424			RK73GB2A102J	CHIP R 1.0K J 1/10W	
R227			RK73GB2A222J	CHIP R 2.2K J 1/10W		R425			RK73GB2A223J	CHIP R 22K J 1/10W	
R228			RK73GB2A101J	CHIP R 100 J 1/10W		R426			RK73GB2A562J	CHIP R 5.6K J 1/10W	
R229			RK73GB2A000J	CHIP R 0.0 J 1/10W		R427			RK73GB2A103J	CHIP R 10K J 1/10W	
R230			RK73GB2A680J	CHIP R 68 J 1/10W		R428			RK73GB2A273J	CHIP R 27K J 1/10W	
R231			RK73GB2A102J	CHIP R 1.0K J 1/10W		R429			RK73GB2A180J	CHIP R 18 J 1/10W	
R232			RK73GB2A104J	CHIP R 100K J 1/10W		R430			RK73GB2A334J	CHIP R 330K J 1/10W	
R233			RK73GB2A000J	CHIP R 0.0 J 1/10W		R431			RK73GB2A473J	CHIP R 47K J 1/10W	
R234			RK73GB2A103J	CHIP R 10K J 1/10W		R432			RK73GB2A684J	CHIP R 680K J 1/10W	
R235			RK73GB2A822J	CHIP R 8.2K J 1/10W		R433			RK73GB2A222J	CHIP R 2.2K J 1/10W	
R236			RK73GB2A102J	CHIP R 1.0K J 1/10W		R434			RK73GB2A223J	CHIP R 22K J 1/10W	
R237, 238			RK73GB2A222J	CHIP R 2.2K J 1/10W		R435			RK73GB2A103J	CHIP R 10K J 1/10W	
R239, 240			RK73GB2A103J	CHIP R 10K J 1/10W		R436			RK73GB2A102J	CHIP R 1.0K J 1/10W	
R241			RK73GB2A222J	CHIP R 2.2K J 1/10W		R437			RK73GB2A101J	CHIP R 100 J 1/10W	
R242			RK73GB2A100J	CHIP R 10 J 1/10W		R438			RK73GB2A103J	CHIP R 10K J 1/10W	
R243, 244			RK73GB2A000J	CHIP R 0.0 J 1/10W		R439			RK73GB2A101J	CHIP R 100 J 1/10W	
R245			RK73GB2A100J	CHIP R 10 J 1/10W		R440, 441			RK73GB2A102J	CHIP R 1.0K J 1/10W	
R246			RK73GB2A102J	CHIP R 1.0K J 1/10W		R442			RK73GB2A104J	CHIP R 100K J 1/10W	
R249			RK73GB2A000J	CHIP R 0.0 J 1/10W		R503			RK73GB2A473J	CHIP R 47K J 1/10W	
R251			RK73GB2A223J	CHIP R 22K J 1/10W		R504			RK73GB2A220J	CHIP R 22 J 1/10W	
R252			RK73GB2A224J	CHIP R 220K J 1/10W		R505			RK73GB2A000J	CHIP R 0.0 J 1/10W	
R253			RK73GB2A334J	CHIP R 330K J 1/10W		R506			RK73GB2A392J	CHIP R 3.9K J 1/10W	
R254			RK73GB2A000J	CHIP R 0.0 J 1/10W		R507			RK73GB2A000J	CHIP R 0.0 J 1/10W	
R255			RK73GB2A331J	CHIP R 330 J 1/10W		R511			RK73GB2A560J	CHIP R 56 J 1/10W	
R256, 257			RK73GB2A332J	CHIP R 3.3K J 1/10W		R512			RK73GB2A103J	CHIP R 10K J 1/10W	
R258			RK73GB2A101J	CHIP R 100 J 1/10W		R513, 514			RK73GB2A100J	CHIP R 10 J 1/10W	
R259			RK73GB2A102J	CHIP R 1.0K J 1/10W		R515			RK73GB2A102J	CHIP R 1.0K J 1/10W	
R261			RK73GB2A474J	CHIP R 470K J 1/10W		R516, 517			RK73GB2A100J	CHIP R 10 J 1/10W	
R262			RK73GB2A104J	CHIP R 100K J 1/10W		R518			RK73GB2A102J	CHIP R 1.0K J 1/10W	
R263			RK73GB2A683J	CHIP R 68K J 1/10W		R519			RK73GB2A103J	CHIP R 10K J 1/10W	
R264			RK73GB2A104J	CHIP R 100K J 1/10W		R520			RK73GB2A471J	CHIP R 470 J 1/10W	
R265			RK73GB2A000J	CHIP R 0.0 J 1/10W		R521			RK73GB2A000J	CHIP R 0.0 J 1/10W	K2
R266			RK73GB2A680J	CHIP R 68 J 1/10W		R521, 522			RK73GB2A000J	CHIP R 0.0 J 1/10W	K
R267			RK73GB2A151J	CHIP R 150 J 1/10W		R522			RK73GB2A100J	CHIP R 10 J 1/10W	K2
R268			RK73GB2A680J	CHIP R 68 J 1/10W		R523			RK73GB2A101J	CHIP R 100 J 1/10W	K2
R269			RK73GB2A104J	CHIP R 100K J 1/10W		R523			RK73GB2A331J	CHIP R 330 J 1/10W	K
R270			RK73GB2A000J	CHIP R 0.0 J 1/10W		R525			RK73GB2A102J	CHIP R 1.0K J 1/10W	
R400			RK73GB2A100J	CHIP R 10 J 1/10W		R526			RK73GB2A182J	CHIP R 1.8K J 1/10W	

PARTS LIST

TX-RX UNIT (X57-6100-XX)

Ref. No.	Address	New parts	Parts No.	Description	Destination	Ref. No.	Address	New parts	Parts No.	Description	Destination
R527			RK73GB2A000J	CHIP R 0.0 J 1/10W		R637, 638			RK73GB2A000J	CHIP R 0.0 J 1/10W	
R528			RK73GB2A154J	CHIP R 150K J 1/10W		R698, 699			RK73GB2A224J	CHIP R 220K J 1/10W	
R529			RK73GB2A104J	CHIP R 100K J 1/10W	K	R700			RK73GB2A393J	CHIP R 39K J 1/10W	
R529			RK73GB2A184J	CHIP R 180K J 1/10W	K2	R701-705			RK73GB2A102J	CHIP R 1.0K J 1/10W	
R530, 531			RK73GB2A102J	CHIP R 1.0K J 1/10W		R706			RK73GB2A000J	CHIP R 0.0 J 1/10W	
R532			RK73GB2A104J	CHIP R 100K J 1/10W		R707			RK73GB2A104J	CHIP R 100K J 1/10W	
R533, 534			RK73GB2A223J	CHIP R 22K J 1/10W		R708			RK73FB2B000J	CHIP R 0.0 J 1/8W	
R535			RK73GB2A222J	CHIP R 2.2K J 1/10W		R710			RK73GB2A000J	CHIP R 0.0 J 1/10W	
R536			RK73GB2A223J	CHIP R 22K J 1/10W		R711			RK73GB2A473J	CHIP R 47K J 1/10W	
R537			RK73GB2A102J	CHIP R 1.0K J 1/10W	K	R712			RK73GB2A104J	CHIP R 100K J 1/10W	
R537			RK73GB2A561J	CHIP R 560 J 1/10W	K2	R713			RK73GB2A473J	CHIP R 47K J 1/10W	
R538			RK73GB2A222J	CHIP R 2.2K J 1/10W		R714			RK73GB2A104J	CHIP R 100K J 1/10W	
R539			RK73GB2A560J	CHIP R 56 J 1/10W		R715-720			RK73GB2A473J	CHIP R 47K J 1/10W	
R541			RK73GB2A331J	CHIP R 330 J 1/10W	K	R722			RK73FB2B000J	CHIP R 0.0 J 1/8W	
R541			RK73GB2A391J	CHIP R 390 J 1/10W	K2	R723			RK73GB2A473J	CHIP R 47K J 1/10W	
R542-545			RK73GB2A222J	CHIP R 2.2K J 1/10W		R725			RK73FB2B000J	CHIP R 0.0 J 1/8W	
R546			RK73GB2A000J	CHIP R 0.0 J 1/10W		R726-728			RK73GB2A473J	CHIP R 47K J 1/10W	
R547			RK73GB2A101J	CHIP R 100 J 1/10W		R729			RK73GB2A154J	CHIP R 150K J 1/10W	
R548			RK73GB2A561J	CHIP R 560 J 1/10W		R730, 731			RK73GB2A334J	CHIP R 330K J 1/10W	
R549			RK73GB2A102J	CHIP R 1.0K J 1/10W		R732, 733			RK73GB2A000J	CHIP R 0.0 J 1/10W	
R550			RK73GB2A224J	CHIP R 220K J 1/10W		R734, 735			RK73GB2A103J	CHIP R 10K J 1/10W	
R552			RK73GB2A331J	CHIP R 330 J 1/10W		R737			RK73GB2A000J	CHIP R 0.0 J 1/10W	
R553			RK73GB2A223J	CHIP R 22K J 1/10W		R738			RK73GB2A473J	CHIP R 47K J 1/10W	
R555			RK73GB2A470J	CHIP R 47 J 1/10W		R739			RK73GB2A103J	CHIP R 10K J 1/10W	
R556, 557			RK73GB2A100J	CHIP R 10 J 1/10W		R740			RK73GB2A473J	CHIP R 47K J 1/10W	
R558			RK73GB2A473J	CHIP R 47K J 1/10W		R741			RK73GB2A223J	CHIP R 22K J 1/10W	
R559			RK73GB2A334J	CHIP R 330K J 1/10W		R742, 743			RK73GB2A184J	CHIP R 180K J 1/10W	
R560			RK73GB2A470J	CHIP R 47 J 1/10W		R744			RK73GB2A223J	CHIP R 22K J 1/10W	
R561			RK73GB2A000J	CHIP R 0.0 J 1/10W		R745			RK73GB2A153J	CHIP R 15K J 1/10W	
R562, 563			RK73GB2A470J	CHIP R 47 J 1/10W		R746			RK73GB2A103J	CHIP R 10K J 1/10W	
R564			RK73GB2A101J	CHIP R 100 J 1/10W		R747			RK73GB2A394J	CHIP R 390K J 1/10W	
R565, 566			RK73GB2A102J	CHIP R 1.0K J 1/10W		R748			RK73GB2A101J	CHIP R 100 J 1/10W	
R567			RK73GB2A000J	CHIP R 0.0 J 1/10W		R749			RK73GB2A104J	CHIP R 100K J 1/10W	
R570			RK73GB2A000J	CHIP R 0.0 J 1/10W	K2	R751			RK73GB2A153J	CHIP R 15K J 1/10W	
R570			RK73GB2A470J	CHIP R 47 J 1/10W	K	R752			RK73GB2A000J	CHIP R 0.0 J 1/10W	
R571			RK73GB2A220J	CHIP R 22 J 1/10W	K	R754			RK73GB2A563J	CHIP R 56K J 1/10W	
R572			RK73GB2A000J	CHIP R 0.0 J 1/10W	K2	R755			RK73GB2A154J	CHIP R 150K J 1/10W	
R600			RK73HB1J473J	CHIP R 47K J 1/16W		R756			RK73GB2A000J	CHIP R 0.0 J 1/10W	
R601			RK73GB2A103J	CHIP R 10K J 1/10W		R757			RK73GB2A562J	CHIP R 5.6K J 1/10W	
R602			RK73GB2A474J	CHIP R 470K J 1/10W		R758			RK73GB2A474J	CHIP R 470K J 1/10W	
R603			RK73GB2A473J	CHIP R 47K J 1/10W		R759			RK73GB2A562J	CHIP R 5.6K J 1/10W	
R604			RK73GB2A103J	CHIP R 10K J 1/10W		R760			RK73GB2A472J	CHIP R 4.7K J 1/10W	
R605			RK73GB2A473J	CHIP R 47K J 1/10W		R761			RK73GB2A333J	CHIP R 33K J 1/10W	
R606			RK73GB2A102J	CHIP R 1.0K J 1/10W		R762			RK73GB2A000J	CHIP R 0.0 J 1/10W	
R607			RK73GB2A100J	CHIP R 10 J 1/10W		R763			RK73GB2A472J	CHIP R 4.7K J 1/10W	
R608			RK73GB2A473J	CHIP R 47K J 1/10W		R764			RK73GB2A223J	CHIP R 22K J 1/10W	
R609			RK73GB2A103J	CHIP R 10K J 1/10W		R765			RK73GB2A334J	CHIP R 330K J 1/10W	
R610			RK73GB2A100J	CHIP R 10 J 1/10W		R766			RK73GB2A104J	CHIP R 100K J 1/10W	
R611-617			RK73GB2A473J	CHIP R 47K J 1/10W		R767			RK73GB2A124J	CHIP R 120K J 1/10W	
R618			RK73GB2A472J	CHIP R 4.7K J 1/10W		R768			RK73GB2A223J	CHIP R 22K J 1/10W	
R619			RK73GB2A473J	CHIP R 47K J 1/10W		R769			RK73GB2A000J	CHIP R 0.0 J 1/10W	
R620			RK73GB2A000J	CHIP R 0.0 J 1/10W		R770			RN73GH1J913D	CHIP R 91K D 1/16W	
R621			RK73GB2A104J	CHIP R 100K J 1/10W		R771			RN73GH1J683D	CHIP R 68K D 1/16W	
R622			RK73GB2A473J	CHIP R 47K J 1/10W		R772			RK73GB2A103J	CHIP R 10K J 1/10W	
R623-627			RK73GB2A102J	CHIP R 1.0K J 1/10W		R773			RN73GH1J333D	CHIP R 33K D 1/16W	
R628			RK73GB2A473J	CHIP R 47K J 1/10W		R774			RN73GH1J913D	CHIP R 91K D 1/16W	
R629			RK73GB2A102J	CHIP R 1.0K J 1/10W		R775			RN73GH1J274D	CHIP R 270K D 1/16W	
R630, 631			RK73GB2A473J	CHIP R 47K J 1/10W		R776			RK73GB2A564J	CHIP R 560K J 1/10W	
R632			RK73GB2A000J	CHIP R 0.0 J 1/10W		R777			RN73GH1J913D	CHIP R 91K D 1/16W	
R634, 635			RK73GB2A000J	CHIP R 0.0 J 1/10W		R778			RK73FB2B000J	CHIP R 0.0 J 1/8W	

PARTS LIST

TX-RX UNIT (X57-6100-XX)

Ref. No.	Address	New parts	Parts No.	Description	Destination	Ref. No.	Address	New parts	Parts No.	Description	Destination
R779			RK73GB2A000J	CHIP R 0.0 J 1/10W		D102			ZSA5A27	ZENER DIODE	
R780			RK73GB2A104J	CHIP R 100K J 1/10W		D103			02DZ15F-X, Y	ZENER DIODE	
R781			RN73GH1J682D	CHIP R 6.8K D 1/16W		D104			1SS355	DIODE	
R782			RK73GB2A472J	CHIP R 4.7K J 1/10W		D105			UDZW4.7(B)	ZENER DIODE	
R783			RK73GB2A155J	CHIP R 1.5M J 1/10W		D106			1SS355	DIODE	
R784, 785			RK73GB2A472J	CHIP R 4.7K J 1/10W		D107			DA204U	DIODE	
R786			RN73GH1J683D	CHIP R 68K D 1/16W		D108			1SS355	DIODE	
R787			RK73GB2A474J	CHIP R 470K J 1/10W		D109			02DZ18F-X, Y	ZENER DIODE	
R788			RK73GB2A472J	CHIP R 4.7K J 1/10W		D201			HSM88AS-E	DIODE K2	
R789			RN73GH1J682D	CHIP R 6.8K D 1/16W		D202-205			KV1470-G	VARIABLE CAPACITANCE DIODE	
R790			RK73GB2A101J	CHIP R 100 J 1/10W		D206			MA3J742	DIODE	
R791, 792			RK73GB2A104J	CHIP R 100K J 1/10W		D207			MA2S111-F	DIODE	
R793			RK73GB2A224J	CHIP R 220K J 1/10W		D208			02DZ5.1F-Y	ZENER DIODE	
R794			RK73GB2A103J	CHIP R 10K J 1/10W		D400			HSC119	DIODE	
R795			RK73GB2A223J	CHIP R 22K J 1/10W		D501-504			MA2S077G	DIODE	
R797			RK73GB2A104J	CHIP R 100K J 1/10W		D701-710			DA204U	DIODE	
R798			RK73GB2A224J	CHIP R 220K J 1/10W		D711			MA3J742	DIODE	
R799			RK73GB2A393J	CHIP R 39K J 1/10W		D912-915			DAP202U	DIODE	
R800			RK73GB2A563J	CHIP R 56K J 1/10W		D916			1SS389-F	DIODE	
R801			RK73GB2A473J	CHIP R 47K J 1/10W		D917			MINISMDC020F	VARIATOR	
R802			RK73GB2A394J	CHIP R 390K J 1/10W		D918			AVRM16080MAAB	VARIATOR	
R803, 804			RK73GB2A271J	CHIP R 270 J 1/10W		IC2			TA75S01F-F	MOS-IC	
R805			RK73GB2A470J	CHIP R 47 J 1/10W		IC101			TC4013BF(N)-F	MOS-IC	
R806			RK73GB2A220J	CHIP R 22 J 1/10W		IC102	*		TDA1519C	ANALOGUE IC	
R807			RK73GB2A333J	CHIP R 33K J 1/10W		IC103			K1A7808AP1	MOS-IC	
R808			RK73GB2A000J	CHIP R 0.0 J 1/10W		IC104			TK11250CMCL-G	BI-POLAR IC	
R809			RK73GB2A473J	CHIP R 47K J 1/10W		IC105			BU4066BCFV	MOS-IC	
R810			RK73GB2A184J	CHIP R 180K J 1/10W		IC201			GN2011(Q)	MOS-IC	
R811			RK73GB2A224J	CHIP R 220K J 1/10W		IC202			TA31136FNG	MOS-IC	
R812			RK73GB2A104J	CHIP R 100K J 1/10W		IC203	*		K1C7S66FU-P	MOS-IC	
R814			RK73GB2A103J	CHIP R 10K J 1/10W		IC400			TA75S01F-F	MOS-IC	
R815			RK73GB2A000J	CHIP R 0.0 J 1/10W		IC401	*		LMH6505MM	ANALOGUE IC	
R816-819		*	RK73EB2E1R0J	CHIP R 1.0 J 1/4W	K2	IC501			LMX2332LTMX	ANALOGUE IC	
R901, 902			RK73GB2A473J	CHIP R 47K J 1/10W		IC601			PST9132NR	MOS-IC	
R903, 904		*	RK73RB2H331J	CHIP R 330 J 1/2W		IC602			TK11250CMCL-G	BI-POLAR IC	
R905-907			RK73GB2A000J	CHIP R 0.0 J 1/10W		IC603			TC7WU04FU-F	MOS-IC	
R908		*	RK73RB2H331J	CHIP R 330 J 1/2W		IC604	*		784214AGC186A	MCU	
R909, 910		*	RK73RB2H221J	CHIP R 220 J 1/2W		IC605			AT24C08BN-SH	ROM IC	
R911		*	RK73RB2H331J	CHIP R 330 J 1/2W		IC606	*		TC7S02FU-F	MOS-IC	
R912			RK73GB2A100J	CHIP R 10 J 1/10W		IC607			AT29C02090TU	ROM IC	
R913			RK73GB2A473J	CHIP R 47K J 1/10W		IC701-704			BU4094BCFV	MOS-IC	
R914, 915		*	RK73RB2H221J	CHIP R 220 J 1/2W		IC705			TA75W01FUF	MOS-IC	
R916-923			RK73GB2A102J	CHIP R 1.0K J 1/10W		IC706, 707			TC75W51FUF	MOS-IC	
R924			RK73GB2A104J	CHIP R 100K J 1/10W		IC708			LC73872M	MOS-IC	
R925			RK73GB2A274J	CHIP R 270K J 1/10W		IC709			TC75W51FUF	MOS-IC	
R926-928			RK73GB2A103J	CHIP R 10K J 1/10W		IC710			M62364FP-F	MOS-IC	
R929			RK73GB2A100J	CHIP R 10 J 1/10W		IC711			TC75W51FUF	MOS-IC	
VR701		*	R32-0688-05	SEMI FIXED VARIABLE RESISTOR		IC712			BU4066BCFV	MOS-IC	
VR901			R31-0630-05	VARIABLE RESISTOR		IC713			TC35453FG6	MOS-IC	
K1			S76-0425-05	RELAY		IC714			TA75W01FUF	MOS-IC	
D1			HSM88AS-E	DIODE		IC715			M62354GPDF0J	MOS-IC	
D3			HSM88AS-E	DIODE		IC901			BU4094BCF	MOS-IC	
D4, 5			1SS355	DIODE		IC902			LC75824W	MOS-IC	
D6			02DZ5.6F-Y	ZENER DIODE		Q1			2SC4649(N, P)	TRANSISTOR	
D101			DSA3A1-FK	DIODE		Q2			2SC3357-A	TRANSISTOR	
						Q3			2SK2596-E	FET	
						Q4, 5			RFM08U9X	FET	
						Q6, 7	A1		2SC2782A	TRANSISTOR	

PARTS LIST

TX-RX UNIT (X57-6100-XX)

Ref. No.	Address	New parts	Parts No.	Description	Destination	Ref. No.	Address	New parts	Parts No.	Description	Destination
Q8			2SK1824-A	FET							
Q9			KTA1298-P (Y)	TRANSISTOR							
Q10			2SK1824-A	FET							
Q11		*	RT1N140U-T111	TRANSISTOR							
Q12			2SB1132 (Q, R)	TRANSISTOR							
Q13			2SK1824-A	FET							
Q14			2SD1757K	TRANSISTOR							
Q101			RT1P141U-T111	TRANSISTOR							
Q102			RT1P144U-T111	TRANSISTOR							
Q103			RT1P141U-T111	TRANSISTOR							
Q104			RT1N144U-T111	TRANSISTOR							
Q105		*	RT1P440U-T111	TRANSISTOR							
Q106			RT1N141U-T111	TRANSISTOR							
Q107			2SK1824-A	FET							
Q108			RT1N141U-T111	TRANSISTOR							
Q109			2SK1824-A	FET							
Q110		*	2SJ506-E (S)	FET							
Q111			RT1P144U-T111	TRANSISTOR							
Q112-115			2SK1824-A	FET							
Q117			2SB1132 (Q, R)	TRANSISTOR							
Q118, 119			KTA1298-P (Y)	TRANSISTOR							
Q121, 122			2SK1824-A	FET							
Q201			2SK2596-E	FET							
Q202-204			2SK508NV (K52)	FET							
Q205			2SC4215-F (Y)	TRANSISTOR							
Q206			2SC4617 (S)	TRANSISTOR							
Q400			3SK294-FP	FET							
Q401			2SA1832 (GR) F	TRANSISTOR							
Q402-405			2SC4738 (GR) F	TRANSISTOR							
Q406			2SA1832 (GR) F	TRANSISTOR							
Q407			2SK1824-A	FET							
Q501			2SC4617 (S)	TRANSISTOR							
Q503		*	3SK131-A (L)	FET							
Q504			2SC4617 (S)	TRANSISTOR							
Q505, 506			2SC4649 (N, P)	TRANSISTOR							
Q507			2SC4617 (S)	TRANSISTOR							
Q601			2SK1824-A	FET							
Q602		*	RT1N140U-T111	TRANSISTOR							
Q701, 702			DTD114EK	DIGITAL TRANSISTOR							
Q703			2SJ243-A	FET							
Q704			2SK1824-A	FET							
Q705			2SJ243-A	FET							
Q706-709			2SK1824-A	FET							
Q901, 902			2SC4617 (S)	TRANSISTOR							
Q903-905			2SK1824-A	FET							
TH1			157-503-65001	THERMISTOR							
TH2, 3			157-104-53001	THERMISTOR							
TH201			157-503-65001	THERMISTOR							

EXPLODED VIEW

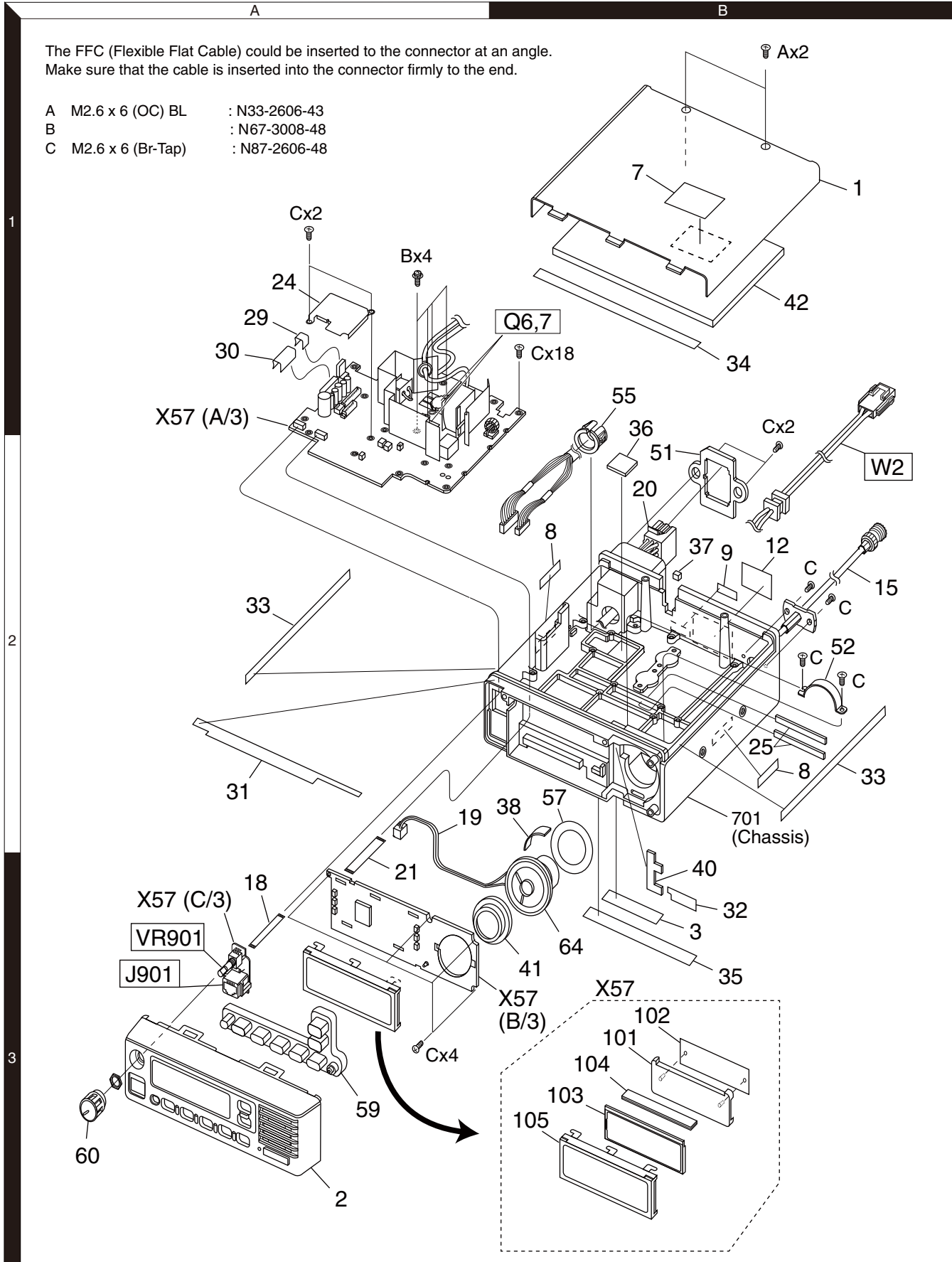

Parts with the exploded numbers larger than 700 are not supplied.

PACKING

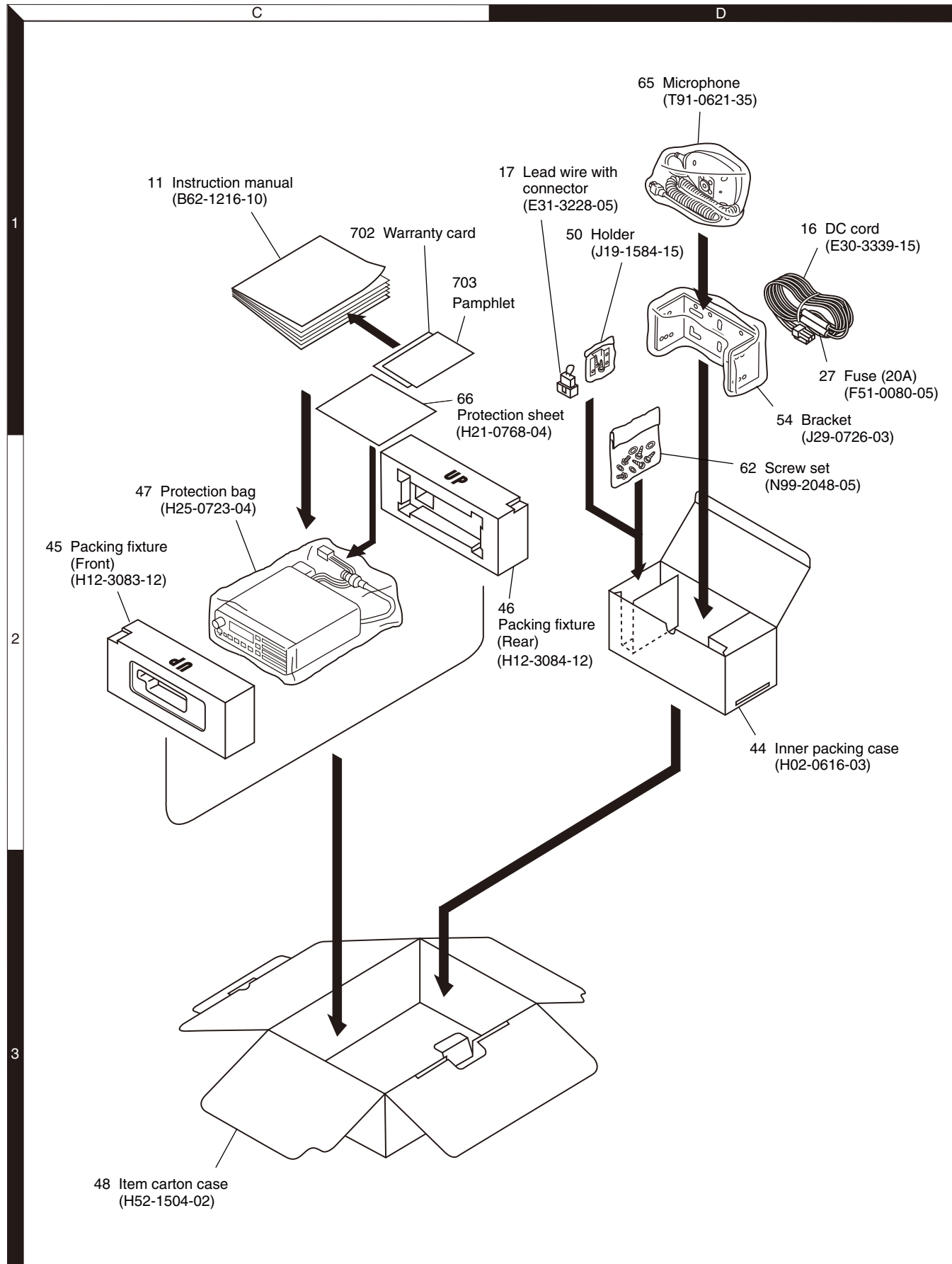

ADJUSTMENT

Key Functions in Panel Test Mode and Panel Tune Mode

Knob/Key	Test mode	Tune mode
▲	Test mode/Tune mode changeover	
▼	Monitor ON/OFF	
SCN	NB ON/OFF	Tuning value back up
MON	Frequency CH down	Tuning item down
A	Frequency CH up	Tuning item up
B	Signalling CH down	Tuning value down
C	Signalling CH up	Tuning value up

Function panel

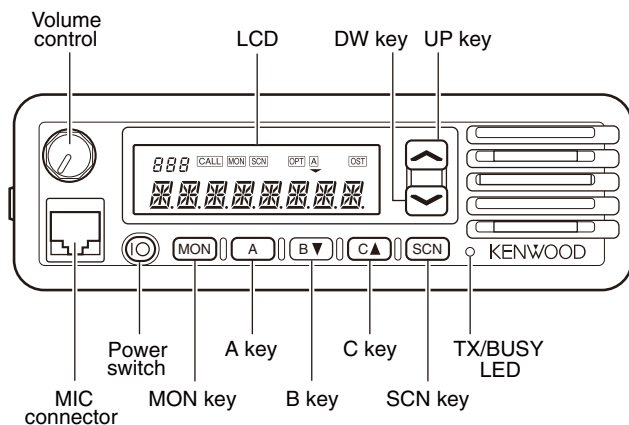

Panel Test Mode

The transceiver's transmission output, receive sensitivity, and other items are measured and QT, DQT, 2-tone and DTMF signaling is decoded in this mode.

■ To enter the panel test mode

Hold down [MON] and turn the power switch on to enter this mode. The test frequency channel and test signalling channel will be displayed.

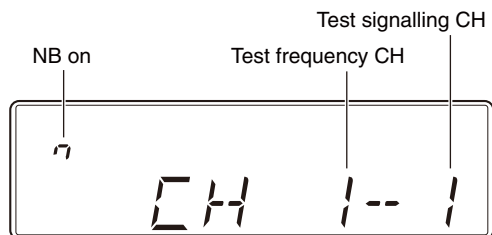

Note : When a key other than GRP down is pressed, the optional signalling is reset.

■ Test frequency channel (MHz) : Default setting

CH	K		K2	
	TX	RX	TX	RX
1 (Center)	33.300	33.400	42.500	42.600
2 (Low)	29.700	29.800	35.000	35.100
3 (High)	37.000	36.900	50.000	49.900
4	33.300	33.300	42.500	42.500
5	33.500	33.500	42.700	42.700
6	33.700	33.700	42.900	42.900

■ Test signalling channel : Default setting

CH No.	Encode tone	Decode tone
1	None	None
2	100Hz square wave	None
3	QT 67.0Hz	QT 67.0Hz
4	QT 151.4Hz	QT 151.4Hz
5	QT 210.7Hz	QT 210.7Hz
6	DQT 023N	DQT 023N
7	Single tone 1633Hz	2-tone 321.7/928.1Hz
8	DTMF [9]	DTMF [159]
9	MSK	None

Panel Tune Mode

The transceiver is adjusted in this mode.

■ To enter the panel tune mode

Press the [▲] key in the panel test mode.

The adjustment items, the frequency and signalling, other than the maximum deviation and sensitivity, return to the values that were effective for the test frequency channel and test signalling channel before entering the panel tune mode.

ADJUSTMENT

Adjustment Points

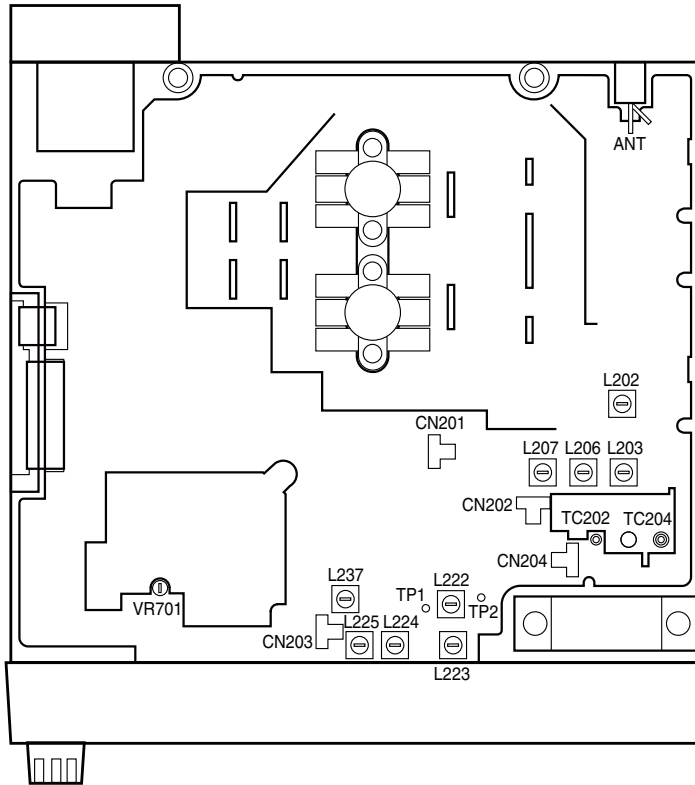

Disassembly for Repair (Speaker)

To install the speaker and to style wiring from the speaker, follow the instructions given in the diagram below.

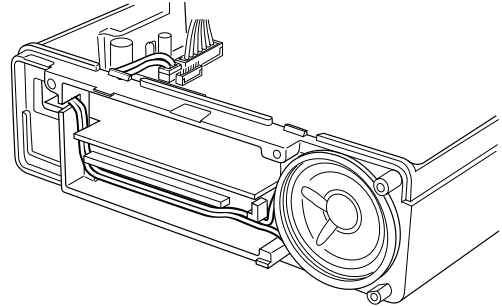

Item	Condition	Measurement			Adjustment			Specifications/Remarks
		Test-equipment	Unit	Terminal	Unit	Parts	Method	
1. PLL lock voltage check Main VCO	1) CH-SIG : 2-1	DC VM Power meter	TX-RX (A/3)	TP1			Check	1.0~1.6V : K
	2) CH-SIG : 3-1							1.7~2.6V : K
	Sub RX-center			TP2				3.0~4.3V : K2
	3) CH-SIG : 1-1							1.7~3.3V
2. Transmit frequency	1) CH-SIG : 1-1 Select FREQ_XXX in tune mode PTT : ON	Power meter f. counter	Rear panel	ANT	Front panel	B key C key	CH1 frequency	±100Hz

ADJUSTMENT

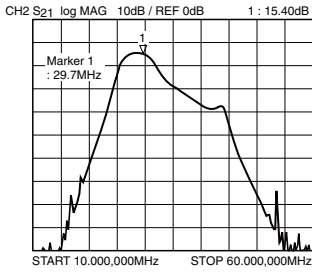
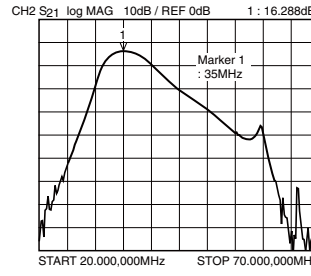
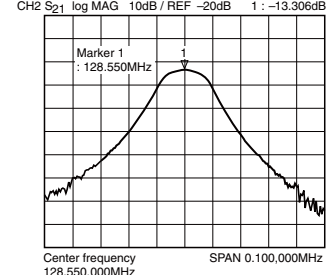
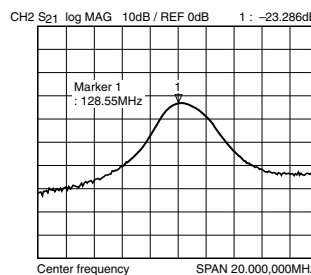
Item	Condition	Measurement			Adjustment			Specifications/Remarks	
		Test-equipment	Unit	Terminal	Unit	Parts	Method		
3. BPF	1) CH-SIG : 2-1 Select __L SENS__75 : K SENS__50 : K2 in tune mode Spectrum analyzer Span : 50MHz Scale : 10dB/div Tracking generator Output : -20dBm	Spectru analyzer Tracking generator	TX-RX (A/3) Rear panel	CN201 ANT	TX-RX (A/3)	L202 L203 L206 L207	Adjust the coils in the following order : L202, L203, L206, L207	Adjust it so it is almost symmetrical, and so the gain is maximum.	
				K				K2	
									
4. MCF	1) CH-SIG : 1-1 Spectrum analyzer Span : 25kHz Scale : 10dB/div Center frequency : 128.55MHz Tracking generator Output : -20dBm	Spectrum analyzer Tracking generator	TX-RX (A/3)	CN203 CN204	TX-RX (A/3)	L222 L223 L224 L225	Adjust it so it is almost symmetrical, and so the gain is maximum. Adjust the coils in the following order : L222, L223, L224, L225.		
									
5. Delay line NB	1) CH-SIG : 1-1 Spectrum analyzer Span : 20MHz Scale : 10dB/div Center frequency : 128.55MHz Tracking generator Output : -20dBm	Spectrum analyzer Tracking generator	TX-RX (A/3)	CN204 CN202	TX-RX (A/3)	TC202 TC204	Adjust it so it is almost symmetrical, and so the gain is maximum.		
									
6. Distortion	1) CH-SIG : 1-1 SSG output : -53dBm/501µV AF output : 1V/4Ω	SSG Distortion meter AF VTVM Oscilloscope 4Ω dummy load	Rear panel	ANT EXT.SP	TX-RX (A/3)	L237	Adjust it, and so the distortion is minimum.	Distortion is minimum.	

ADJUSTMENT

Item	Condition	Measurement			Adjustment			Specifications/Remarks
		Test-equipment	Unit	Terminal	Unit	Parts	Method	
7. RF power	1) RF power _POW_XXX Adjust the RF power. All values in Low, Center and High frequencies changes one time. 2) Select __L _POW_XXX in tune mode PTT : ON 3) Select __C _POW_XXX in tune mode PTT : ON 4) Select __H _POW_XXX in tune mode PTT : ON	Power meter Ammeter	Rear panel	ANT	Front panel	B key C key	70W 15A or less	70w \pm 1.0W 15A or less
8. Maximum deviation	1) CH-SIG : 1-1 Select MXDV_XXX in tune mode PTT : ON Deviation meter filter HPF : OFF, LPF : 15kHz De-emphasis : OFF AG : 1kHz/50mV	Power meter Deviation meter	Rear panel	ANT	Front panel	B key C key	\pm 4.05kHz	\pm 0.1kHz
9. MIC sensitivity	1) CH-SIG : 1-1 PTT : ON Deviation meter filter HPF : OFF LPF : 15kHz De-emphasis : OFF AG : 1kHz/5mV	AF VTVM AG Oscilloscope	Front panel	MIC	TX-RX (A/3)	VR701	Check	2.2~3.8kHz
10. QT deviation	1) CH-SIG : 1-4 Select QTDV_XXX in tune mode PTT : ON Deviation meter filter HPF : OFF LPF : 3kHz De-emphasis : OFF				Front panel	B key C key	\pm 0.75kHz	\pm 0.05kHz
11. DQT deviation	1) CH-SIG : 1-6 Select DQDV_XXX in tune mode PTT : ON Deviation meter filter HPF : OFF, LPF : 3kHz De-emphasis : OFF						\pm 0.75kHz	\pm 0.05kHz
12. DTMF deviation	1) CH-SIG : 1-8 Select DTDV_XXX in tune mode PTT : ON Deviation meter filter HPF : OFF, LPF : 15kHz De-emphasis : OFF						\pm 3.0kHz	\pm 0.1kHz
13. MSK deviation	1) CH-SIG : 1-9 Select MSDV_XXX in tune mode PTT : ON Deviation meter filter HPF : OFF, LPF : 15kHz De-emphasis : OFF						\pm 3.0kHz	\pm 0.1kHz

ADJUSTMENT

Item	Condition	Measurement			Adjustment			Specifications/Remarks		
		Test-equipment	Unit	Terminal	Unit	Parts	Method			
14. Sensitivity	1) Sensitivity SENS_XXX Adjust the sensitivity. All values in Low, Center and High frequencies changes one time.	SSG AF VTVM Distortion meter Oscilloscope 4Ω dummy load	Rear panel	ANT	Front panel	B key C key	Low check Center check High check	SINAD 12dB or more		
				EXT.SP	TX-RX (A/3)	L237				
	2) Select __L SENS__75 : K SENS__50 : K2 in tune mode SSG output : -116dBm/0.35μV AF output : 0.25μV/4Ω									
	3) Select __C SENS_130in tune mode									
	4) Select __H SENS_230in tune mode									
15. Squelch tight point	1) Squelch tight point SQ_T_XXX Adjust the squelch tight point. All values in Low, Center and High frequencies changes one time.				Front panel	B key C key	Adjust to point of opening squelch			
	2) Select __L SQ_T_XXXin tune mode SSG output : Value when 7dB is added from the sensitivity value of 12dB SINAD. NB : ON									
	3) Select __C SQ_T_XXXin tune mode									
	4) Select __H SQ_T_XXXin tune mode									
16. Squelch open point	1) Squelch open point SQ_O_XXX Adjust the squelch open point. All values in Low, Center and High frequencies changes one time.						Adjust to point of opening squelch	SINAD 12dB or more		
	2) Select __L SQ_O_XXXin tune mode SSG output : Value when 3dB is subtracted from the sensitivity value of 12dB SINAD. NB : ON									
	3) SSG output : OFF					Check			Squelch must be closed.	
	4) Select __C SQ_O_XXXin tune mode				Front panel	B key C key			Adjust to point of opening squelch	
	5) SSG output : OFF								Check	Squelch must be closed.
	6) Select __H SQ_O_XXXin tune mode				Front panel	B key C key			Adjust to point of opening squelch	
	7) SSG output : OFF								Check	Squelch must be closed.
17. NB	1) CH-SIG : 1-1 SSG output : -109dBm/0.8μV Pulse generator Output : 0.5Vp-p/50Ω Cycle : 100μsec Pulse width : 10ns NB : ON	SSG Pulse generator Distortion meter Oscilloscope AF VTVM	Rear panel	ANT			Check	SINAD 12dB or more		
				EXT.SP						

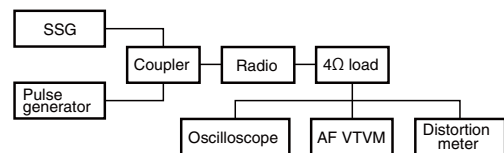

TK-6110 PC BOARD

TX-RX UNIT : TX-RX SECTION
 (X57-6100-XX)(A/3, C/3)
 Component side view
 (J79-0225-09)

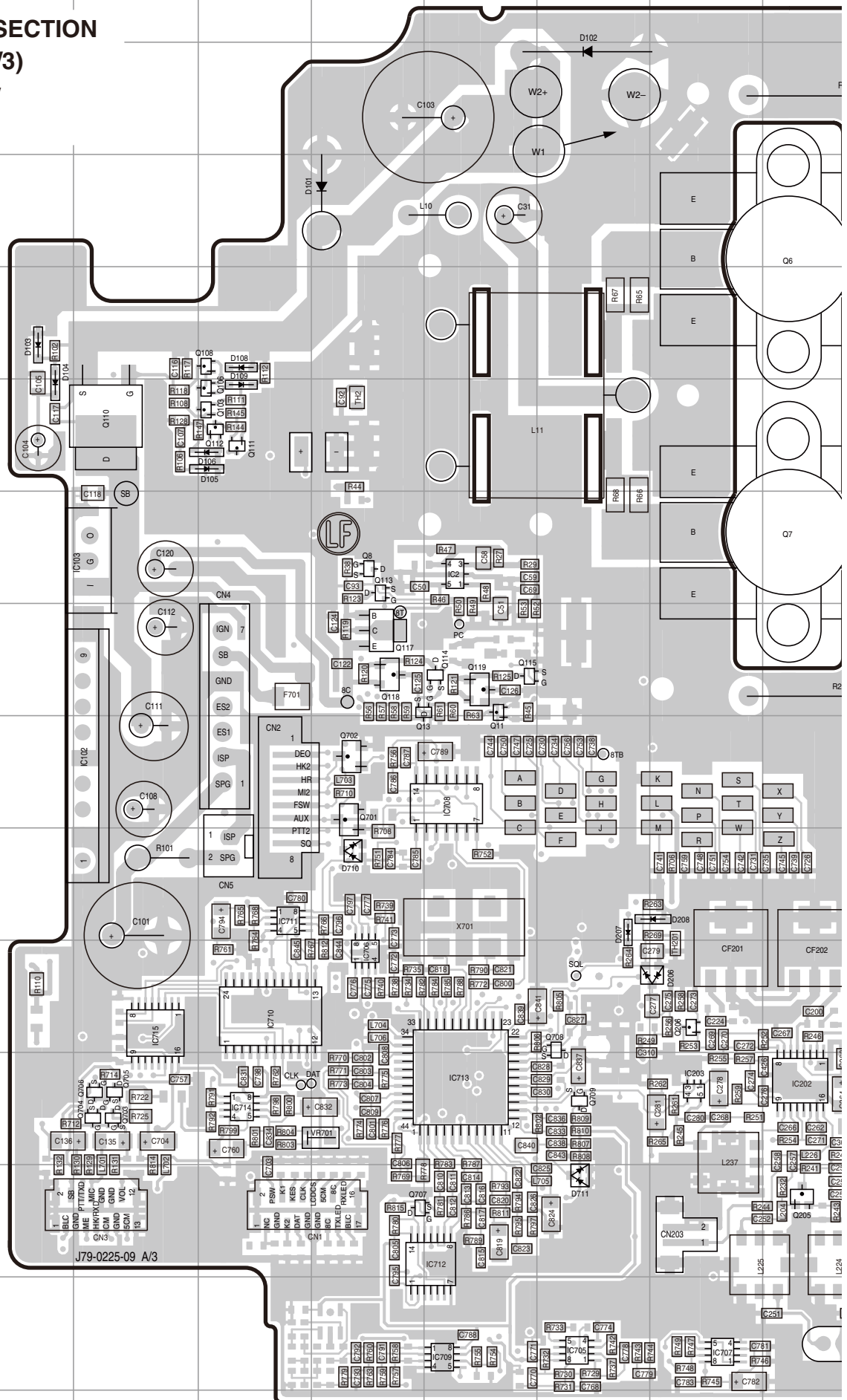

Component side

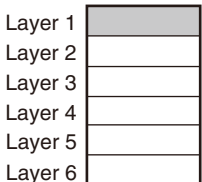

PC BOARD TK-6110

TX-RX UNIT : TX-RX SECTION
(X57-6100-XX)(A/3, C/3)
Component side view
(J79-0225-09)

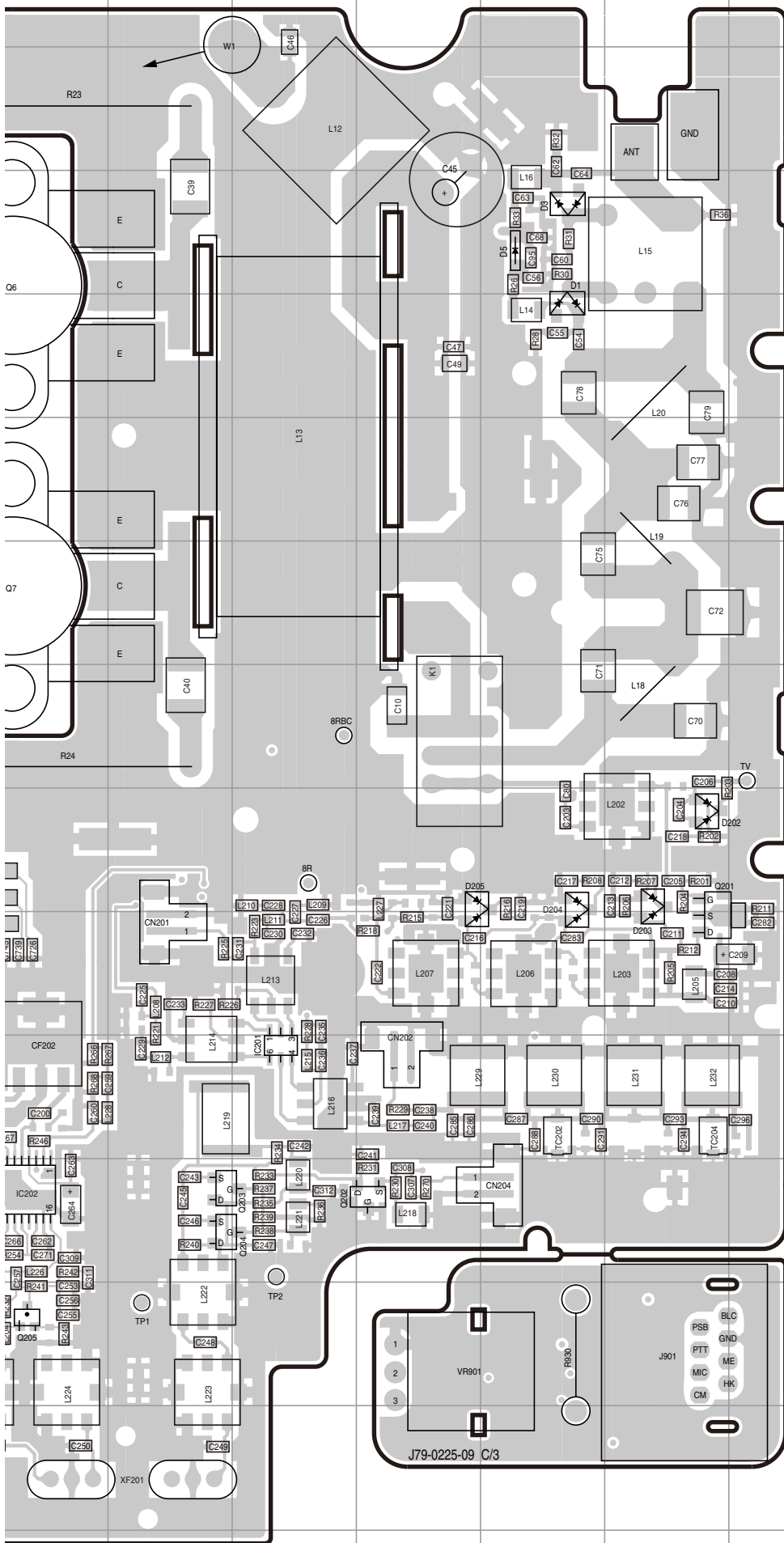

Ref. No.	Address	Ref. No.	Address
IC2	6G	Q202	11M
IC102	8D	Q203	11K
IC103	6D	Q204	11K
IC201	10L	Q205	12J
IC202	11J	Q206	10I
IC203	11I	Q701	8F
IC705	13H	Q702	8F
IC706	10F	Q703	11D
IC707	13I	Q704	11D
IC708	8G	Q705	11D
IC709	13G	Q706	11D
IC710	10E	Q707	12F
IC711	9E	Q708	10H
IC712	12G	Q709	11H
IC713	11G	D1	4N
IC714	11E	D3	3N
IC715	10D	D5	3N
Q6	3J	D101	3F
Q7	6J	D102	2H
Q8	6F	D103	4C
Q11	7G	D104	5C
Q13	7F	D105	5E
Q103	5E	D106	5E
Q106	5E	D108	4E
Q108	4E	D109	5E
Q110	5D	D202	8O
Q111	5E	D203	8O
Q112	5E	D204	8N
Q113	6F	D205	8M
Q114	7G	D206	10I
Q115	7G	D207	9H
Q117	7F	D208	9I
Q118	7F	D710	9F
Q119	7G	D711	12H
Q201	9O		

J79-0225-09 C/3

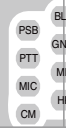

TK-6110 PC BOARD

TX-RX UNIT : TX-RX SECTION
(X57-6100-XX)(A/3, C/3)
Foil side view
(J79-0225-09)

Ref. No.	Address	Ref. No.	Address
IC101	4P	Q401	9E
IC104	11P	Q402	9E
IC105	10P	Q403	9E
IC400	9F	Q404	9E
IC401	8F	Q405	9E
IC501	12K	Q407	10F
IC601	9M	Q501	9K
IC602	9O	Q503	8J
IC603	9N	Q504	10H
IC604	11N	Q505	10K
IC605	10O	Q506	9I
IC606	11O	Q507	8H
IC607	12N	Q601	10L
IC701	8M	Q602	10L
IC702	8M	D4	7G
IC703	8L	D6	7H
IC704	8N	D107	5P
Q1	8K	D201	8E
Q2	7M	D400	10E
Q3	6N	D501	8J
Q4	5N	D502	8J
Q5	4N	D503	8I
Q9	7M	D504	8I
Q10	7G	D701	12P
Q12	7N	D702	12Q
Q101	5Q	D703	12P
Q102	5P	D704	8N
Q104	5P	D705	12Q
Q105	7P	D706	9N
Q107	7P	D707	12P
Q109	7P	D708	8N
Q121	10P	D709	8N
Q122	10P	D917	12E
Q400	9G	D918	12E

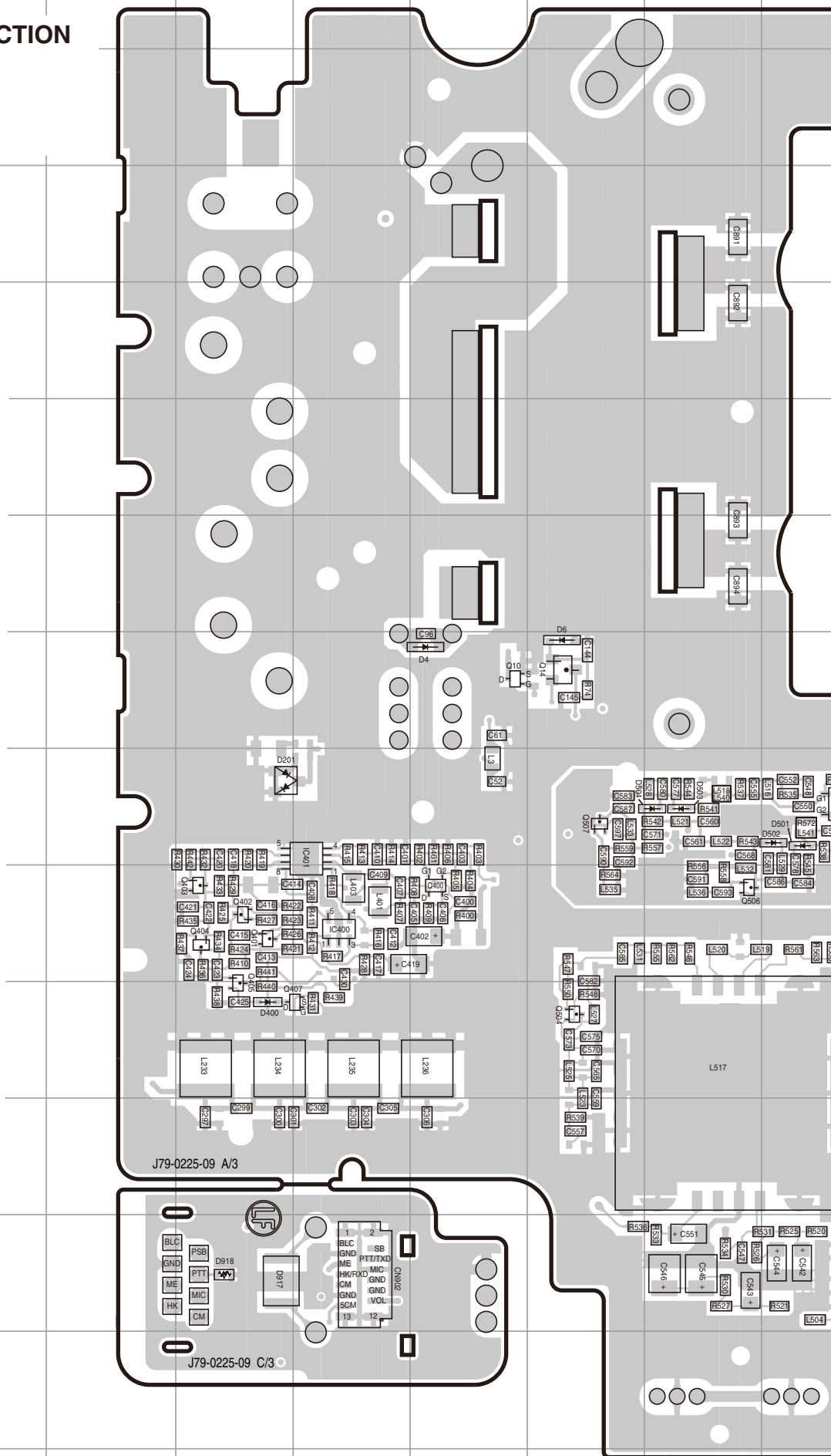

TK-6110 PC BOARD

TX-RX UNIT : DISPLAY SECTION (X57-6100-XX)(B/3) Component side view (J79-0225-09)

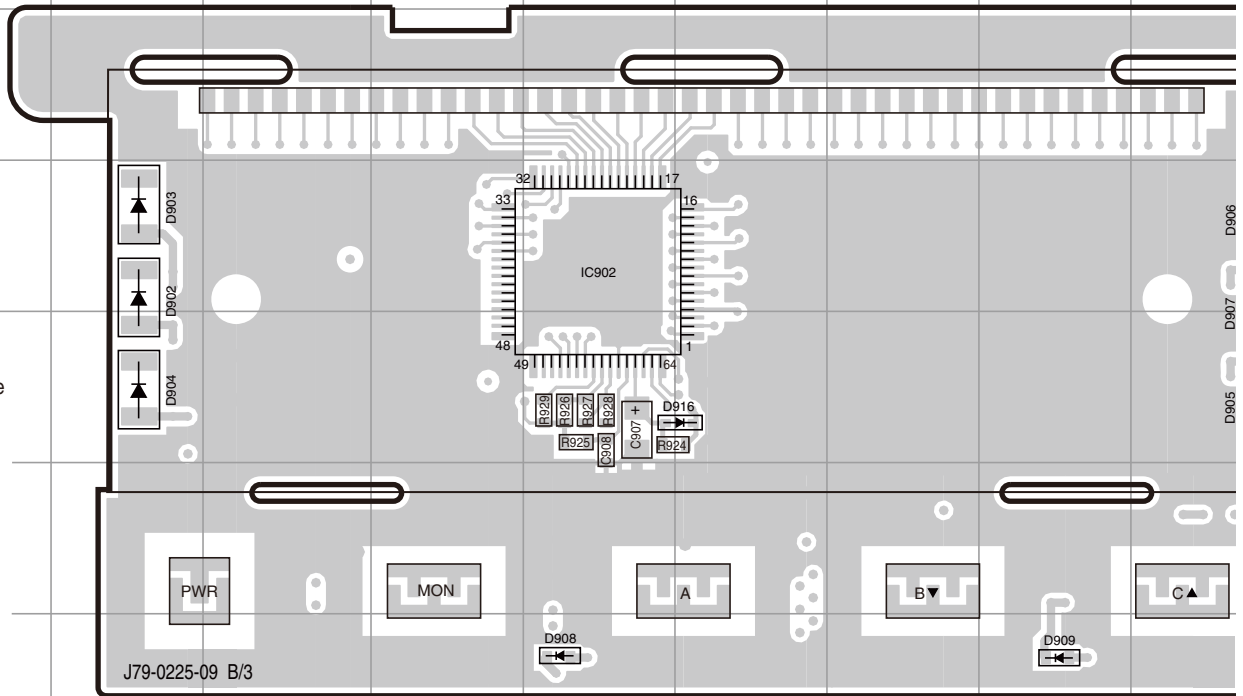
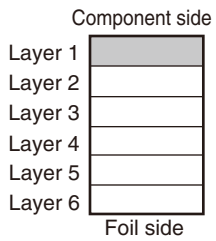

TX-RX UNIT : DISPLAY SECTION (X57-6100-XX)(B/3) Foil side view (J79-0225-09)

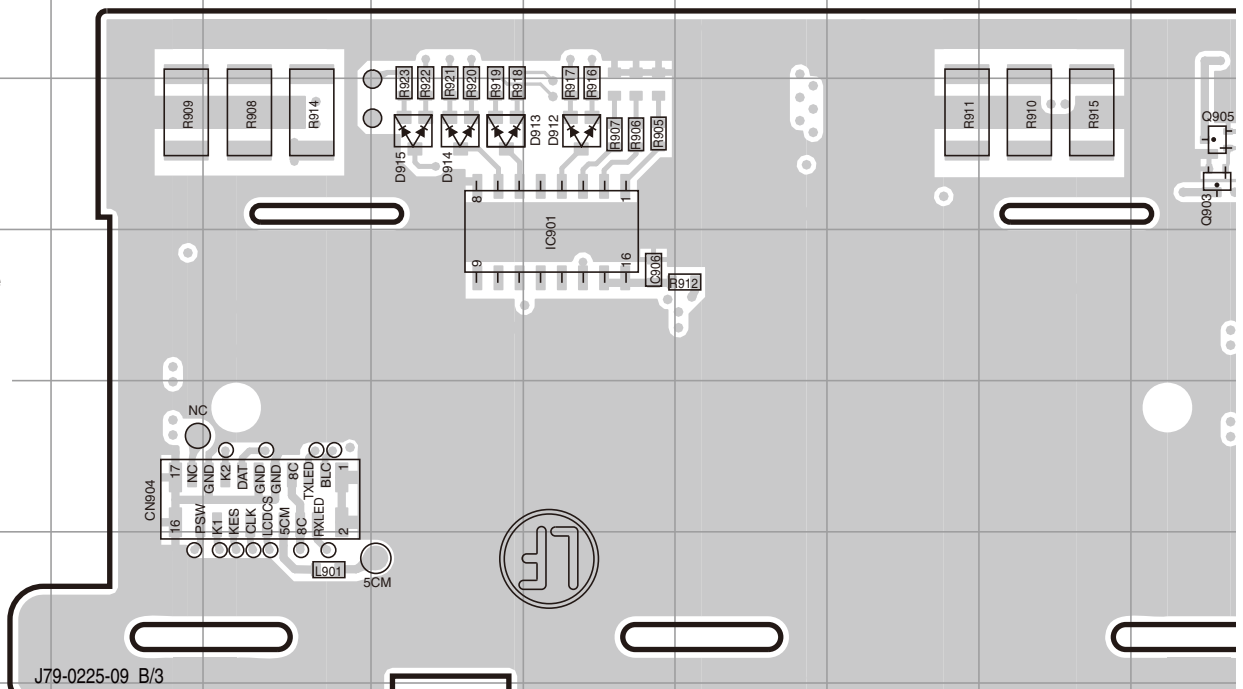
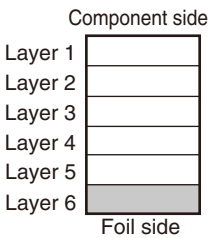

PC BOARD TK-6110

TX-RX UNIT : DISPLAY SECTION (X57-6100-XX)(B/3) Component side view (J79-0225-09)

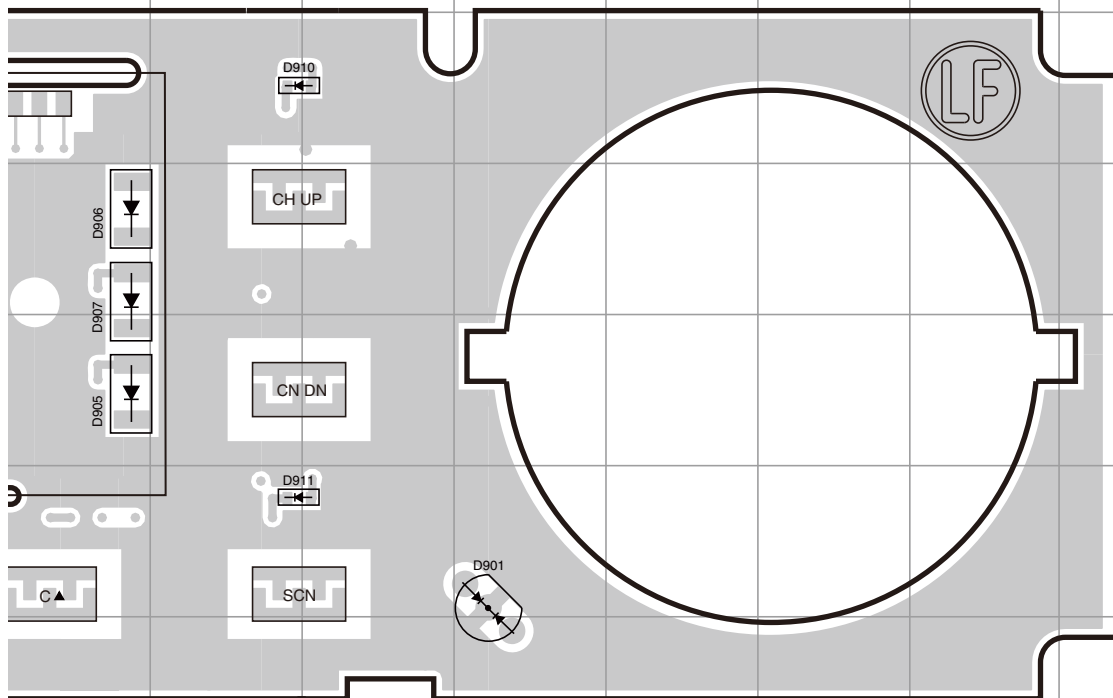

Ref. No.	Address
IC902	4F
D901	6M
D902	4C
D903	4C
D904	5C
D905	5J
D906	3J
D907	4J
D908	7F
D909	7I
D910	3K
D911	6K
D916	5G

TX-RX UNIT : DISPLAY SECTION (X57-6100-XX)(B/3) Foil side view (J79-0225-09)

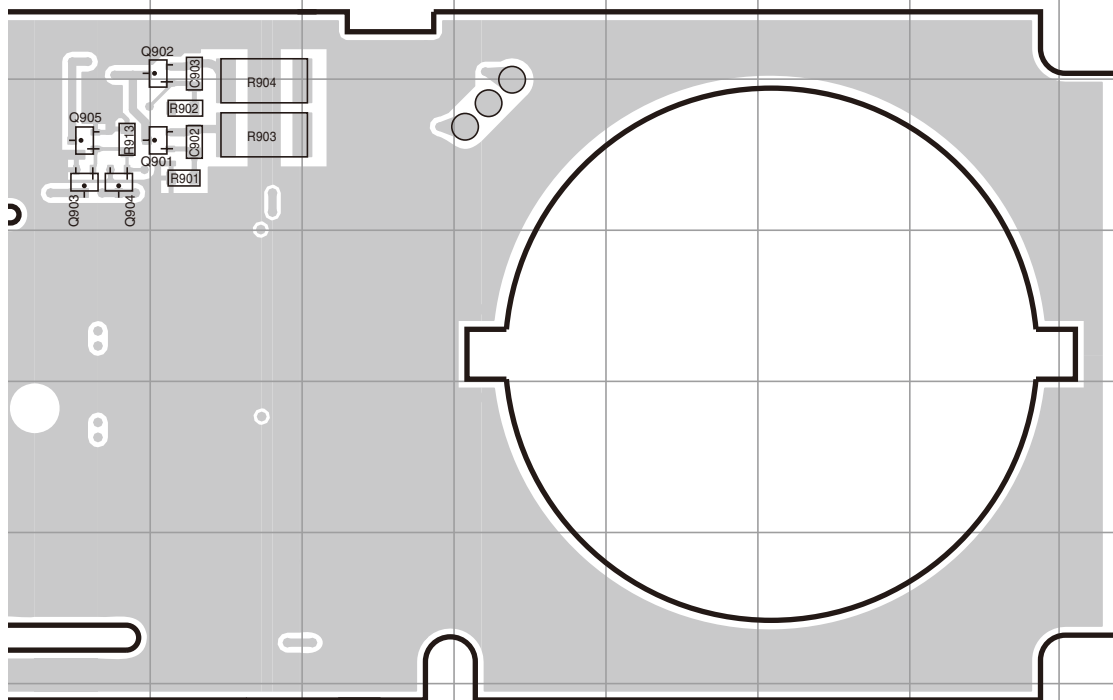

Ref. No.	Address
IC901	10F
Q901	10K
Q902	9K
Q903	10J
Q904	10J
Q905	10J
D912	10F
D913	10E
D914	10E
D915	10E

TK-6110 SCHEMATIC DIAGRAM

TX-RX UNIT TX-RX SECTION X57-6100-XX A/3

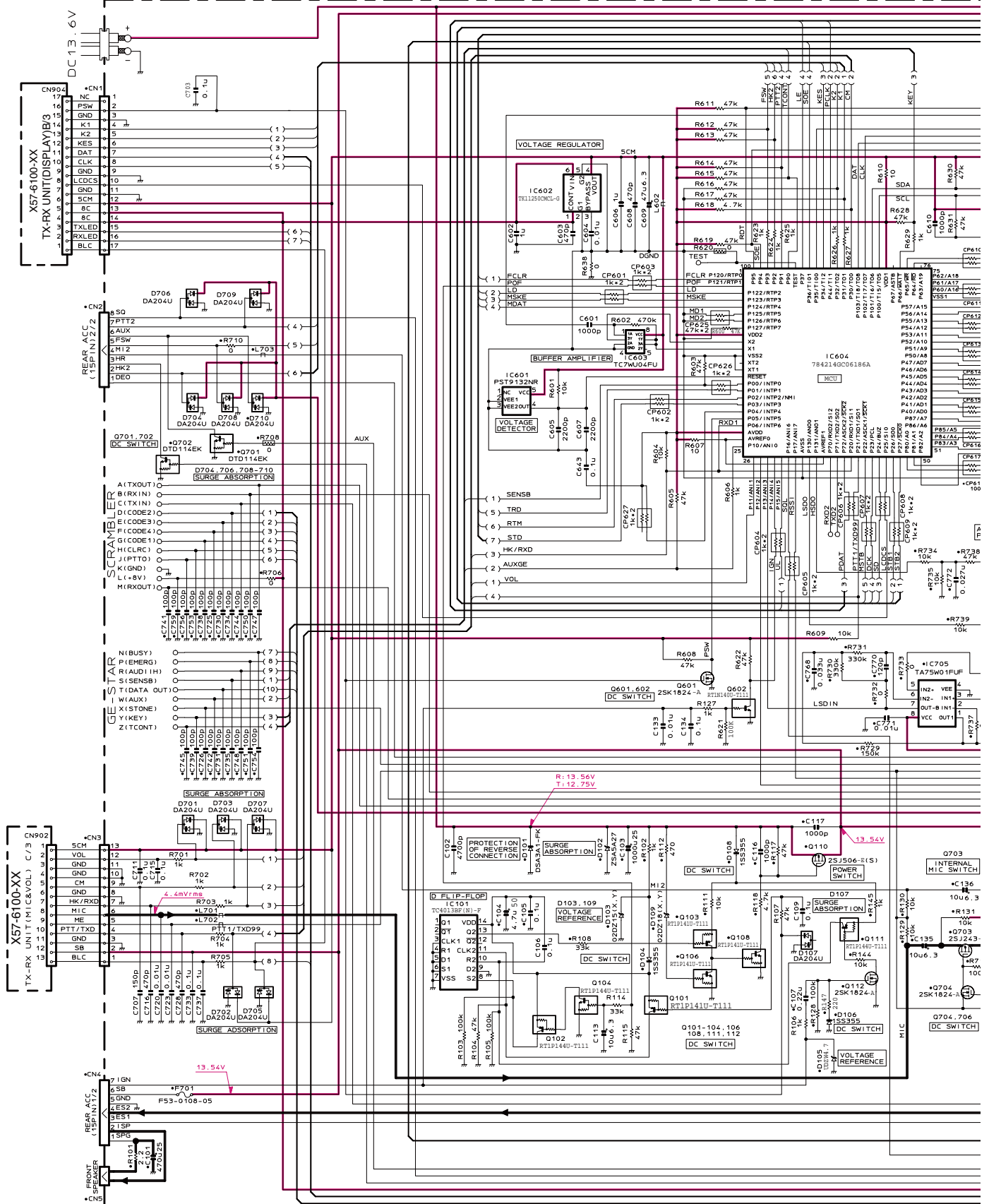

X57-6100-XX	D201	L2	L5	L13	L18	L19	L20	L26	L201	L202	L203	L206	L207	L212	L514	L516	L518	L540	L541	R1	R7	R8	R9	R11	R37	R41	R52	R73	R404	R522		
0-10	K	NO	330u	1u	L39-1432-35	L34-4895-05	L34-4884-05	L34-4889-05	NO	82u	L34-4862-05	L34-4862-05	L34-4862-05	L34-4862-05	270u	56u	220u	220u	NO	10u	47k	33u	18u	0	NO	0	NO	330u	0			
0-11	K2	8088A2-E	270u	220u	L39-1523-05	L34-4883-05	L34-4883-05	L34-4885-05	68u	NO	L34-4860-05	L34-4860-05	L34-4860-05	L34-4860-05	220u	47u	NO	NO	270u	NO	33k	NO	NO	NO	NO	12k	NO	330	120	33	270k	10

TK-6110 SCHEMATIC DIAGRAM

TX-RX UNIT(X57-6100-XX)

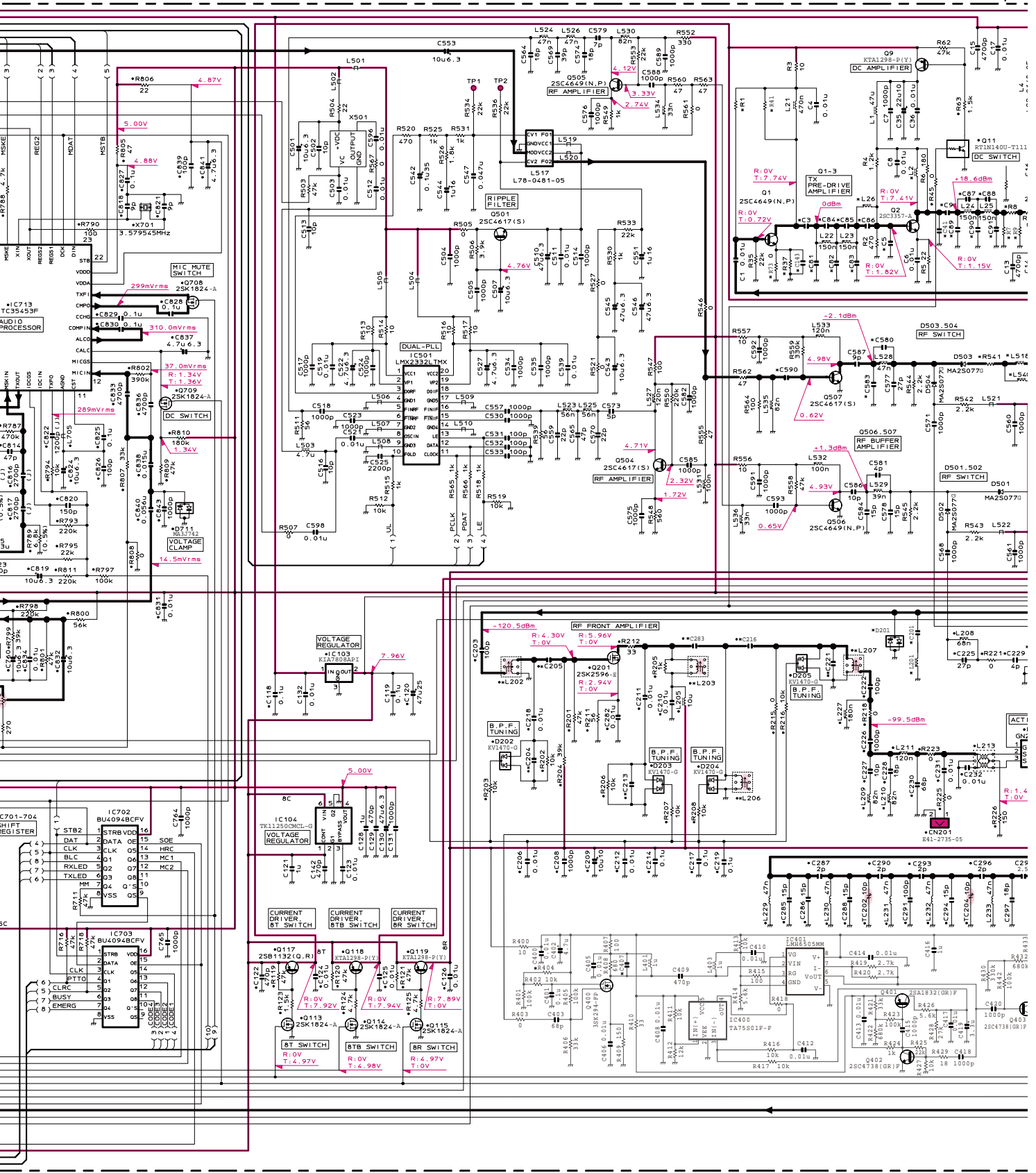

00	01	09	C143	C201	C204	C205	C211	C216	C221	C283	C407	C529	C549	C550	C555	C580	C583	C590	C591	C594	C595	C598	
02	09	502	033-1738-03	1 80	1 39	80	1 39	80	1 39	80	1 39	1 39	1 39	1 39	1 39	1 39	1 39	1 39	1 39	1 39	1 39	1 39	1 39
00	00	470	033-1744-05	0.01u	NO	5p	47p	5p	180p	5p	33p	120p	150p	100p	6p	NO	NO	NO	82p	220p	220p	NO	NO

SCHEMATIC DIAGRAM TK-6110

TX-RX UNIT(X57-6100-XX)

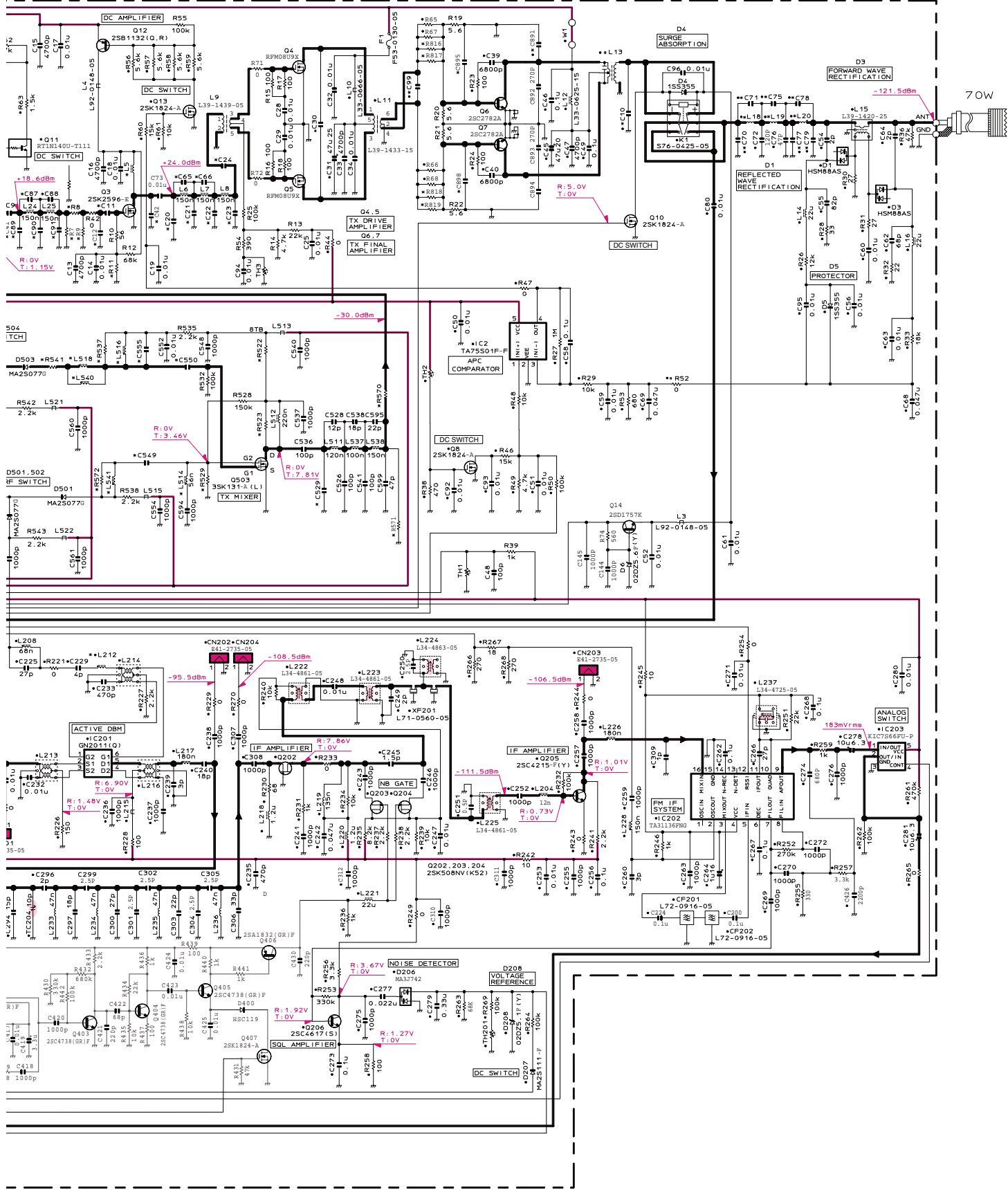

Note : The components marked with a dot (•) are parts of layer 1.

TK-6110 SCHEMATIC DIAGRAM

TX-RX UNIT DISPLAY SECTION X57-6100-XX B/3

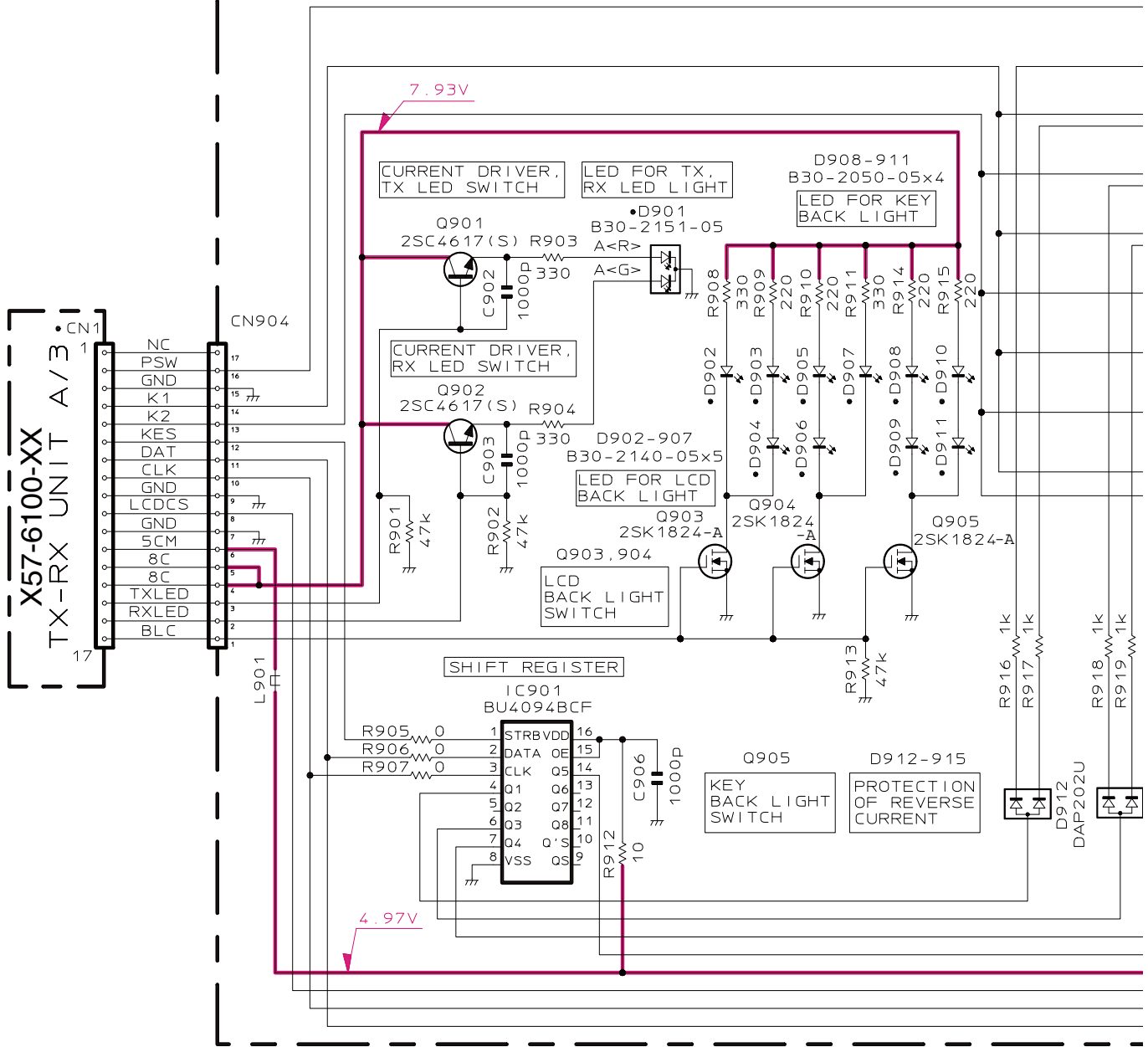

TX-RX UNIT MIC & VOL SECTION X57-6100-XX C/3

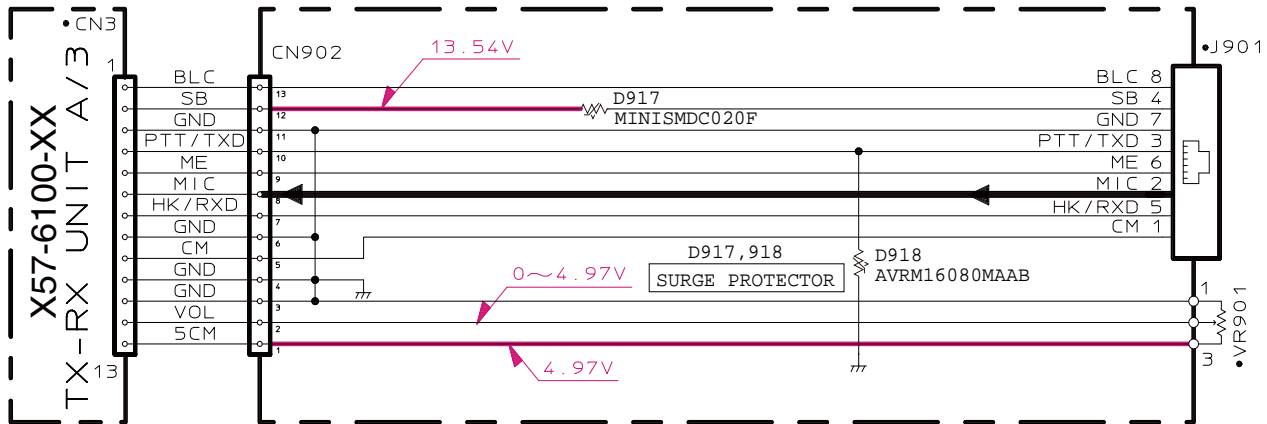

SCHEMATIC DIAGRAM TK-6110

▼ TX-RX UNIT(X57-6100-XX)

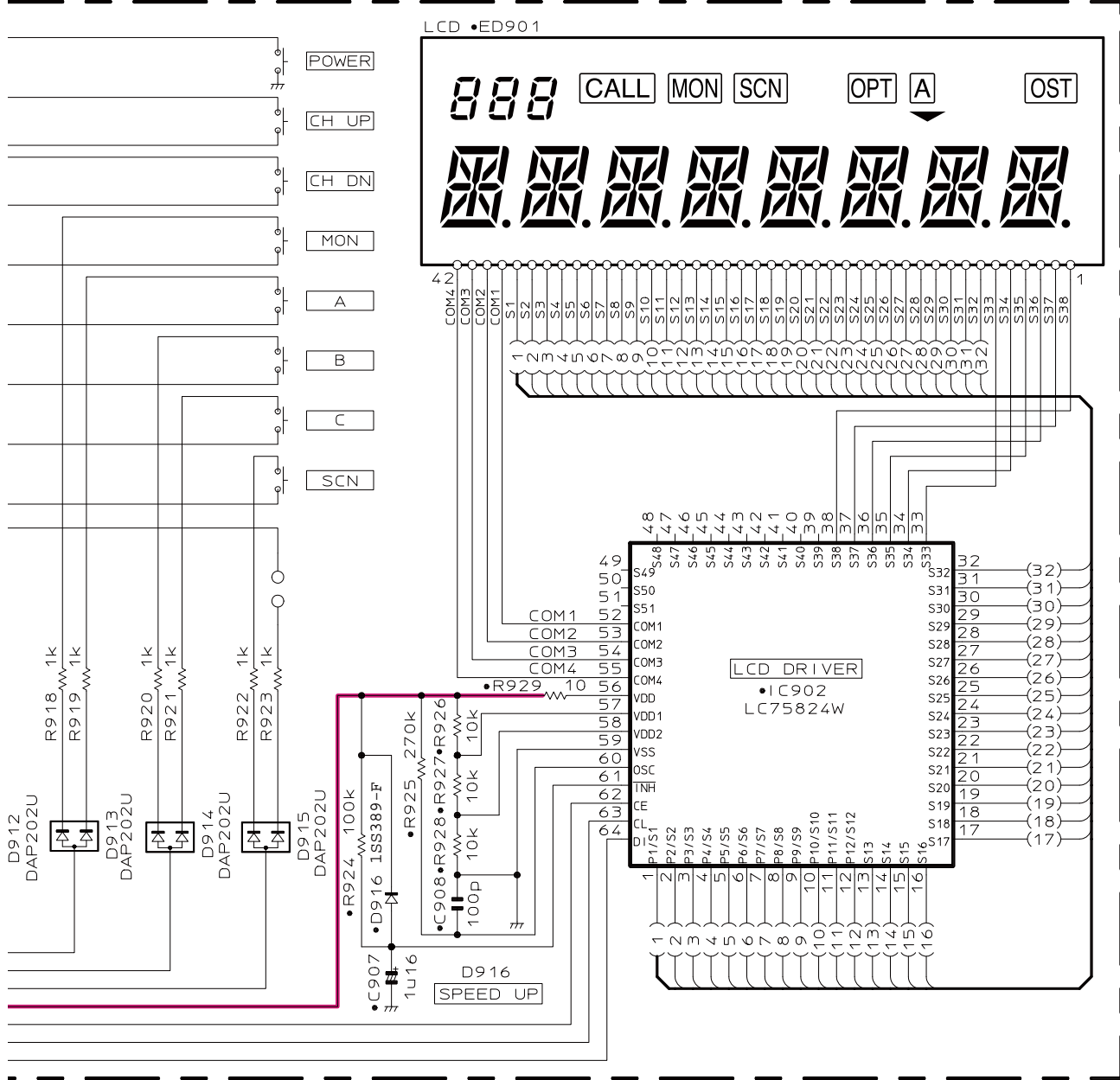

Note : The components marked with a dot (●) are parts of layer 1.

TK-6110

Kenwood Corporation

2967-3, Ishikawa-machi, Hachioji-shi, Tokyo, 192-8525 Japan

Kenwood U.S.A. Corporation

P.O. BOX 22745, 2201 East Dominguez Street, Long Beach,
CA 90801-5745, U.S.A.

Kenwood Electronics Canada Inc.

6070 Kestrel Road, Mississauga, Ontario, Canada L5T 1S8

Kenwood Electronics Deutschland GmbH

Rembrücker Str. 15, 63150 Heusenstamm, Germany

Kenwood Electronics Belgium N.V.

Leuvensesteenweg 248 J, 1800 Vilvoorde, Belgium

Kenwood Electronics France S.A.

L' Etoile Paris Nord 2, 50 Allée des Impressionnistes,
Bp 58416 Villepinte, 95944 Roissy Ch De Gaulle Cedex

Kenwood Electronics UK Limited

KENWOOD House, Dwight Road, Watford, Herts.,
WD18 9EB United Kingdom

Kenwood Electronics Europe B.V.

Amsterdamseweg 37, 1422 AC Uithoorn, The Netherlands

Kenwood Electronics Italia S.p.A.

Via G. Sirtori, 7/9 20129 Milano, Italy

Kenwood Ibérica, S.A.

Bolivia, 239-08020 Barcelona, Spain

Kenwood Electronics Australia Pty. Ltd.

Talavera Business Park Building A, 4 Talavera Road,
North Ryde NSW 2113 Australia

Kenwood Electronics (Hong Kong) Ltd.

Suite 2504, 25/F, Tower 2, Nina Tower, No. 8 Yeung Uk Road,
Tsuen Wan, New Territories, Hong Kong

Kenwood Electronics Singapore Pte Ltd

1 Ang Mo Kio Street 63, Singapore 569110

TK-6110 PC BOARD

TX-RX UNIT : TX-RX SECTION
 (X57-6100-XX)(A/3, C/3)
 Component side view
 (J79-0225-09)

PC BOARD TK-6110

TX-RX UNIT : TX-RX SECTION
 (X57-6100-XX)(A/3, C/3)
 Component side view
 (J79-0225-09)

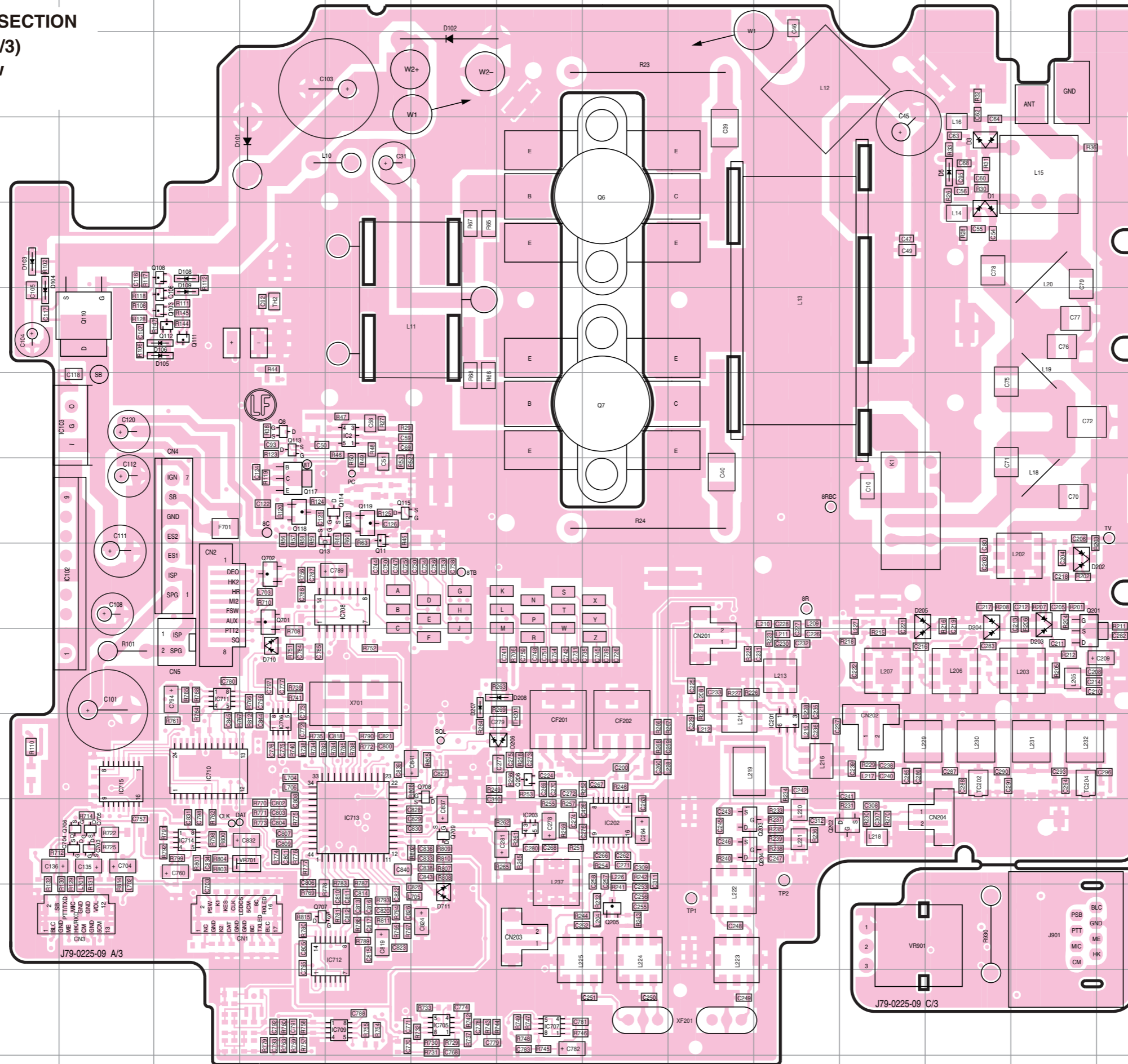

Ref. No.	Address	Ref. No.	Address
IC2	6G	Q202	11M
IC102	8D	Q203	11K
IC103	6D	Q204	11K
IC201	10L	Q205	12J
IC202	11J	Q206	10I
IC203	11I	Q701	8F
IC705	13H	Q702	8F
IC706	10F	Q703	11D
IC707	13I	Q704	11D
IC708	8G	Q705	11D
IC709	13G	Q706	11D
IC710	10E	Q707	12F
IC711	9E	Q708	10H
IC712	12G	Q709	11H
IC713	11G	D1	4N
IC714	11E	D3	3N
IC715	10D	D5	3N
Q6	3J	D101	3F
Q7	6J	D102	2H
Q8	6F	D103	4C
Q11	7G	D104	5C
Q13	7F	D105	5E
Q103	5E	D106	5E
Q106	5E	D108	4E
Q108	4E	D109	5E
Q110	5D	D202	8O
Q111	5E	D203	8O
Q112	5E	D204	8N
Q113	6F	D205	8M
Q114	7G	D206	10I
Q115	7G	D207	9H
Q117	7F	D208	9I
Q118	7F	D710	9F
Q119	7G	D711	12H
Q201	9O		

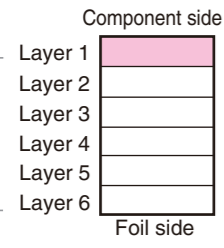

TK-6110 PC BOARD

TX-RX UNIT : TX-RX SECTION
(X57-6100-XX)(A/3, C/3)
Foil side view
(J79-0225-09)

PC BOARD TK-6110

TX-RX UNIT : TX-RX SECTION
(X57-6100-XX)(A/3, C/3)
Foil side view
(J79-0225-09)

Ref. No.	Address	Ref. No.	Address
IC101	4P	Q401	9E
IC104	11P	Q402	9E
IC105	10P	Q403	9E
IC400	9F	Q404	9E
IC401	8F	Q405	9E
IC501	12K	Q407	10F
IC601	9M	Q501	9K
IC602	9O	Q503	8J
IC603	9N	Q504	10H
IC604	11N	Q505	10K
IC605	10O	Q506	9I
IC606	11O	Q507	8H
IC607	12N	Q601	10L
IC701	8M	Q602	10L
IC702	8M	D4	7G
IC703	8L	D6	7H
IC704	8N	D107	5P
Q1	8K	D201	8E
Q2	7M	D400	10E
Q3	6N	D501	8J
Q4	5N	D502	8J
Q5	4N	D503	8I
Q9	7M	D504	8I
Q10	7G	D701	12P
Q12	7N	D702	12Q
Q101	5Q	D703	12P
Q102	5P	D704	8N
Q104	5P	D705	12Q
Q105	7P	D706	9N
Q107	7P	D707	12P
Q109	7P	D708	8N
Q121	10P	D709	8N
Q122	10P	D917	12E
Q400	9G	D918	12E

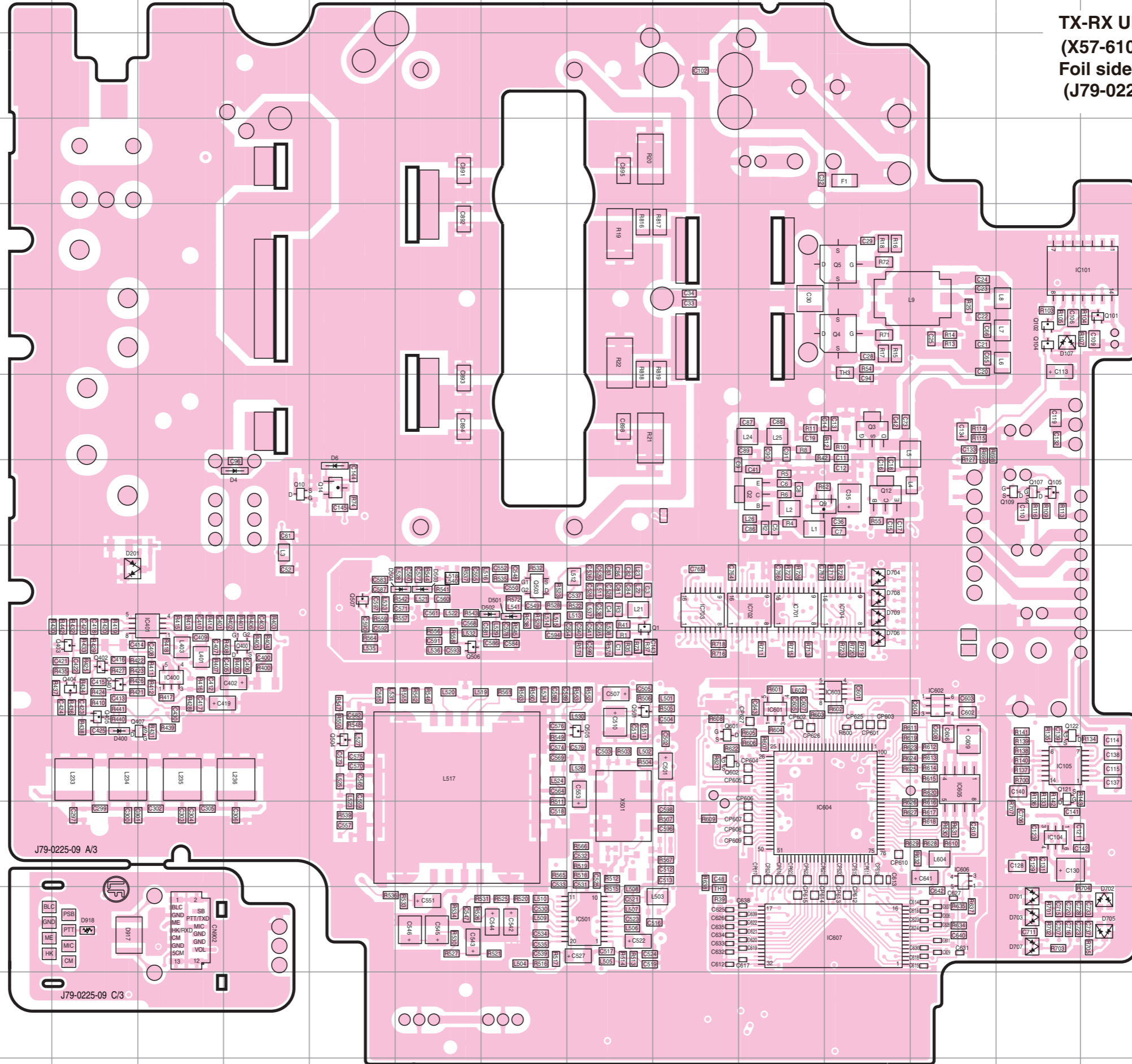

TK-6110 PC BOARD

PC BOARD TK-6110

TX-RX UNIT : DISPLAY SECTION (X57-6100-XX)(B/3) Component side view (J79-0225-09)

TX-RX UNIT : DISPLAY SECTION (X57-6100-XX)(B/3) Component side view (J79-0225-09)

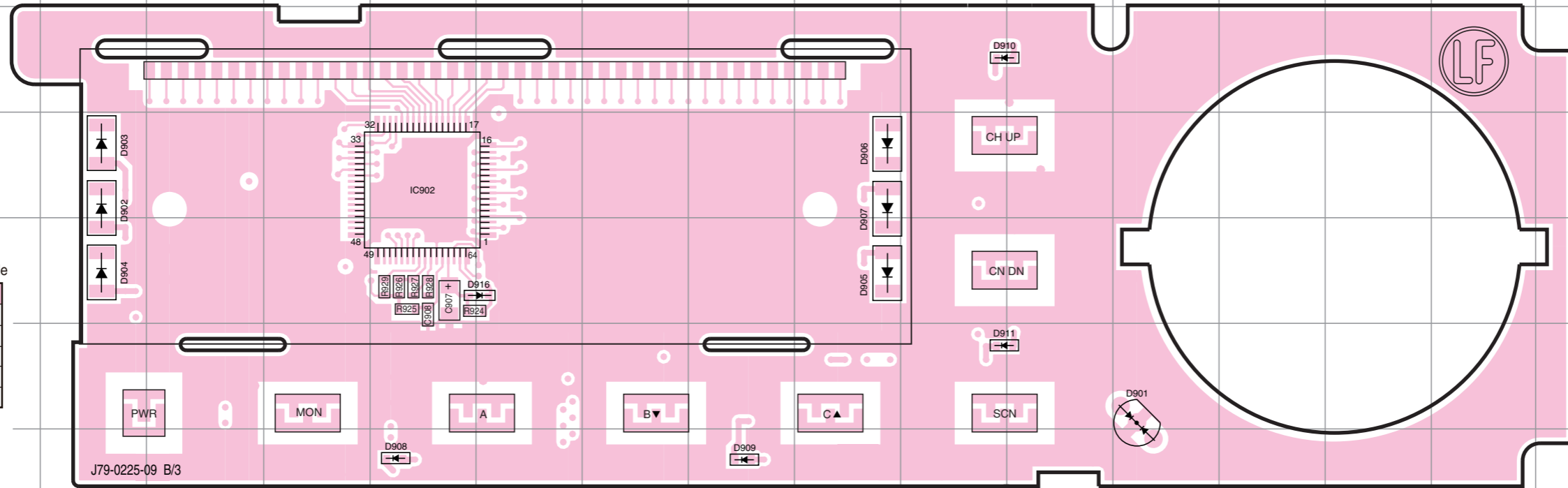
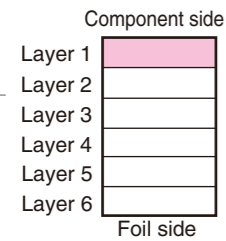

Ref. No.	Address
IC902	4F
D901	6M
D902	4C
D903	4C
D904	5C
D905	5J
D906	3J
D907	4J
D908	7F
D909	7I
D910	3K
D911	6K
D916	5G

TX-RX UNIT : DISPLAY SECTION (X57-6100-XX)(B/3) Foil side view (J79-0225-09)

TX-RX UNIT : DISPLAY SECTION (X57-6100-XX)(B/3) Foil side view (J79-0225-09)

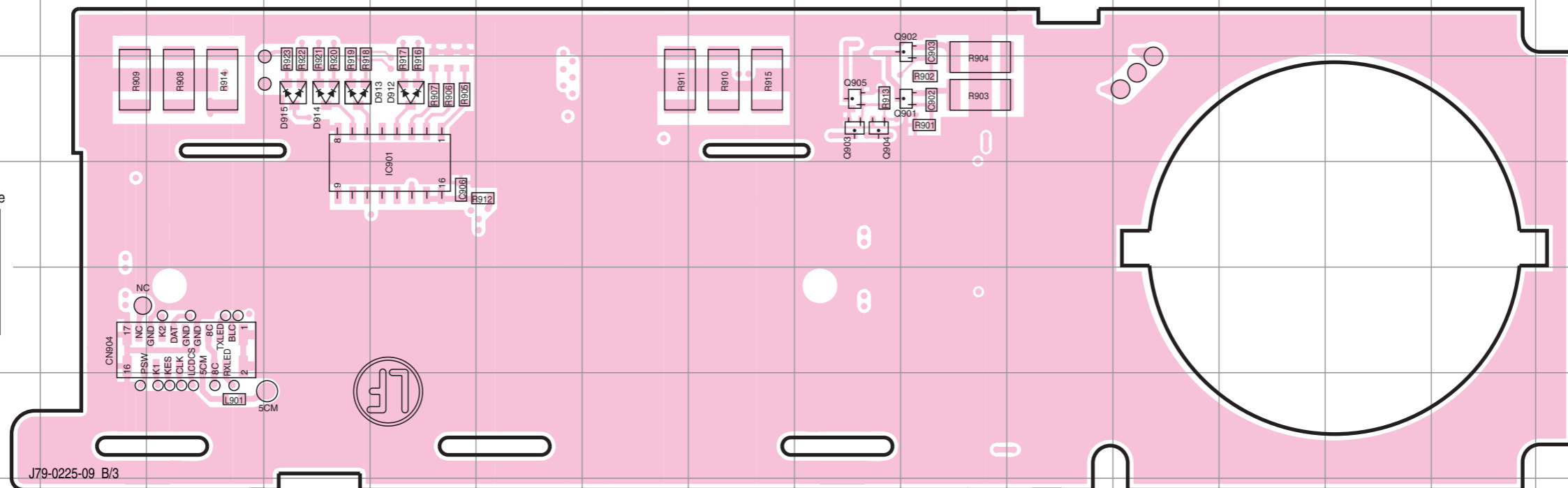
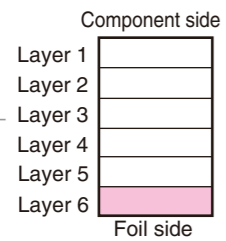

Ref. No.	Address
IC901	10F
Q901	10K
Q902	9K
Q903	10J
Q904	10J
Q905	10J
D912	10F
D913	10E
D914	10E
D915	10E

TX-RX UNIT TX-RX SECTION X57-6100-XX A/3

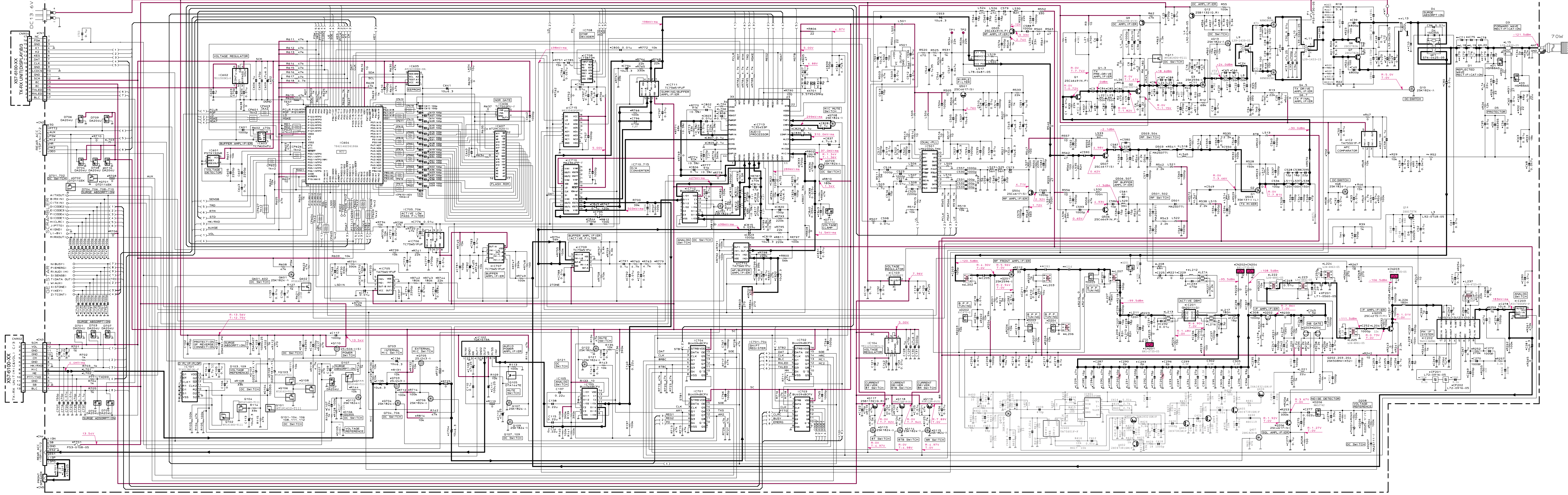

X57-6100-XX	001	12	13	14	15	16	17	18	19	20	21	22	23	24	25	26	27	28	29	30	31	32	33	34	35	36	37	38	39	40	41	42	43	44	45	46	47	48	49	50	51	52	53	54	55	56	57	58	59	60	61	62	63	64	65	66	67	68	69	70	71	72	73	74	75	76	77	78	79	80	81	82	83	84	85	86	87	88	89	90	91	92	93	94	95	96	97	98	99	100
-------------	-----	----	----	----	----	----	----	----	----	----	----	----	----	----	----	----	----	----	----	----	----	----	----	----	----	----	----	----	----	----	----	----	----	----	----	----	----	----	----	----	----	----	----	----	----	----	----	----	----	----	----	----	----	----	----	----	----	----	----	----	----	----	----	----	----	----	----	----	----	----	----	----	----	----	----	----	----	----	----	----	----	----	----	----	----	----	----	----	----	-----

TK-6110 SCHEMATIC DIAGRAM

Note : Components marked with a dot (·) are parts of patterun 1.

TX-RX UNIT DISPLAY SECTION X57-6100-XX B/3

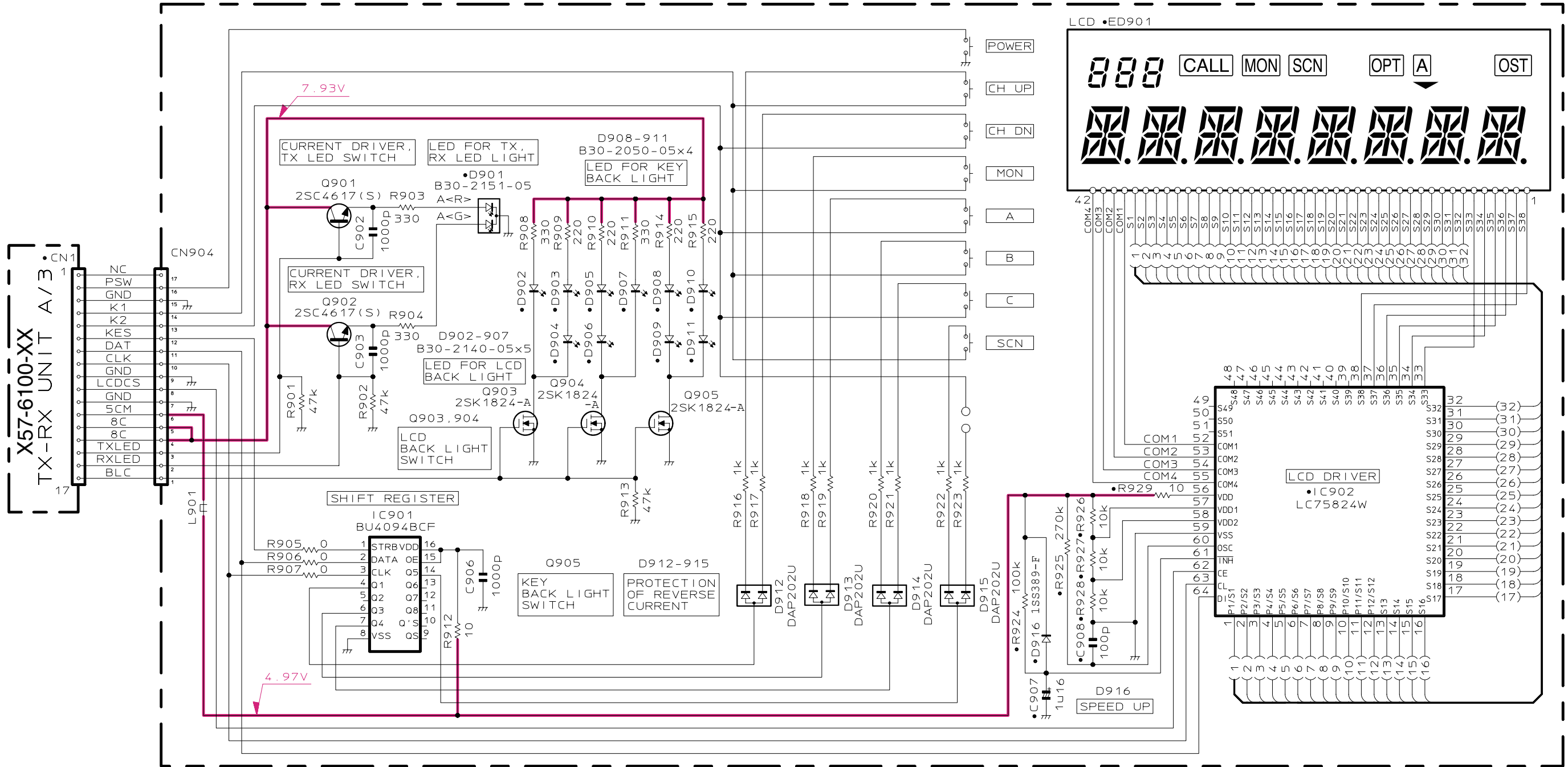

TX-RX UNIT MIC & VOL SECTION X57-6100-XX C/3

